

Teacher Support: Coursework Guidance Booklet

AS GCE Physical Education

OCR Advanced Subsidiary GCE in Physical Education H154

This Teacher Support: Coursework Guidance booklet is designed to accompany the OCR Advanced Subsidiary GCE specification in Physical Education for teaching from September 2008.

1	Introduction	2
1.1	Planning	2
1.2	Categories of Physical Activities	3
1.3	Assessment	5
1.4	Moderation	7
1.5	Internal Standardisation	8
1.6	Minimum Coursework Requirements	9
1.7	Special Arrangements	9
1.8	Authentication	9
1.9	Submission of log books for Moderation	9
1.10	Special Activity Submission Criteria	10
2	Unit G452: Acquiring, developing and evaluating practical skills in Physical Education	11
2.1	Introduction	11
2.2	Unit Content	12
2.3	Unit Assessment	15
3	Performance - Activity Profiles and Assessment Criteria	20
3.1	Athletic Activities	20
3.2	Combat Activities	32
3.3	Dance activities	45
3.4	Invasion Games	55
3.5	Net/wall Games	94
3.6	Striking/Fielding Games	106
3.7	Target Games	118
3.8	Gymnastic Activities	127
3.9	Outdoor and Adventurous Activities	138
3.10	Swimming Activities	162
3.11	Safe and effective exercise activities	168
4	Coaching and Leading – Assessment criteria	174
5	Officiating – Assessment criteria	179
6	Evaluation and Planning for Improvement	185

1 Introduction

Coursework is set and marked by the Centre and externally moderated by OCR.

1.1 Planning

The philosophy of the OCR Advanced Subsidiary GCE and Advanced GCE Physical Education specifications is that the performance of practical activities is a central and integral part of the course. Wherever possible in the delivery of the course, theory is related to practice and practice related to theory.

Physical activities make a significant contribution to aims and objectives, serving as a source of material and to facilitate learning. They should be selected as representative of the varied physical activities available to Centres and to those that candidates have experienced within the National Curriculum and/or GCSE Physical Education. The selection should be influenced by:

- relevance to the course content areas;
- interests, stages of development and abilities of candidates;
- traditions and practices in the Centre and the local community;
- teaching resources and the expertise of staff;
- facilities and equipment;
- time;
- candidate numbers.

Centres may wish to maximise time by combining AS/A2 candidates for some practical work and indeed the diversity of activities may necessitate the use of extra curricular activities and local clubs as sources of practical activities for candidates. In the latter case the Centre **must** retain the responsibility for monitoring the work and its assessment.

Centres should also implement continuous assessment, both as a means of allowing candidates to monitor their improvement and ensuring that if injury/illness occurs, some records are available.

1.2 Categories of Physical Activities

This specification classifies physical activities into eight contexts. These contexts are those identified in the National Curriculum with the addition of combat activities and safe and effective exercise activities. The eight contexts are:

Athletic Activities

The performance and refinement of a range of dynamic skills with the intention of improving personal and collective bests in relation to speed, height, distance and accuracy.

e.g. track and field athletics

Combat Activities

Performers select, develop, apply and adapt skills, strategies and tactics with the intention of outwitting their opponent in a range of different combats.

e.g. judo

Dance Activities

Performers use their imagination and ideas to create, perform, appreciate and develop dances with an awareness of historical and cultural contexts. The artistic intention makes use of rhythm, space and relationships, expressing and communicating ideas, moods and feelings.

e.g. contemporary dance

Game Activities

Performers select, apply and adapt skills, strategies and tactics, on their own and in teams, with the intention of outwitting the opposition in a range of different game types.

The Game Activity context is sub-divided into four categories:

- Invasion Games – *e.g. association football.*
- Net/Wall Games – *e.g. badminton.*
- Striking/Fielding Games – *e.g. cricket.*
- Target Games – *e.g. golf.*

Gymnastic Activities

Performers devise aesthetically pleasing sequences using combinations of skills and agility which they repeat and perform with increasing control, precision and fluency.

e.g. trampolining

Outdoor and Adventurous Activities

Performers develop, individually and in teams, the ability to analyse, plan and then respond effectively and safely to physical challenges and problems they encounter in familiar, changing and unfamiliar environments.

e.g. mountain walking

Swimming Activities and Water Safety

Performers develop the confidence and ability to stay afloat and to swim unaided for sustained periods of time, selecting, adapting and refining their skills so that they can swim safely and engage in a variety of different activities in and around water.

e.g. competitive swimming

Safe and Effective Exercise

Performers develop the ability to design and implement training programmes which are targeted and progressive, aiming to develop particular muscle groups, muscle fibres and/or energy systems in an identified time frame. Performers demonstrate knowledge of health and safety considerations and are able to evaluate the success of the training programmes.

e.g. circuit training.

Each Centre will differ in its approach to the range of activities it offers and in the way it structures them. As with their theoretical studies, it is expected that candidates will supplement and enhance their curriculum time with time spent on their practical activities outside their course. Candidates are likely to build on in-depth practical activity experiences gained within Key Stage 4 and in some cases GCSE Physical Education. Centres should enable candidates to continue to experience a broad range of practical activities in order to enhance their application and appreciation of performance issues whilst also specialising in their two selected activities.

In Module G452 candidates follow a minimum of two practical activities which are chosen from two of the eleven different activity profiles described. In module G454 candidates follow a minimum of one practical activity chosen from the eleven different activity categories.

The activities within the coursework place candidates in physically demanding situations. Centres should ensure that candidates are medically capable of coping with this. Where doubt exists medical advice should be sought.

Each of the practical activities offered to candidates should be carried out in accordance with the recommendations in ‘*Safe Practice in Physical Education*’ (BAALPE Current Edition).

1.3 Assessment

Centres need to be aware of the importance of submitting provisional entries for Units G452 and G454. Provisional entry forms will be sent out to centres in September for completion and return back to OCR by mid October in the year prior to examination. Provisional entry information is used as a basis for apportioning coursework Moderators. Failure to submit provisional entries may result in a centre receiving late notification of the moderation process.

Units G452 and G454 are only available for entry in the June series.

In Unit G452 candidates are assessed in two activities from two of the eight different activity categories described in section 1.2.

In Unit G454 candidates are assessed in one activity from one of the eleven different activity profiles.

Assessment should be continuous, not only to provide candidates with an indication of their progress, but also so that in the case of injury, there is some indication of the candidate's improvement and standard.

In Centres where a diverse range of practical activities is offered to candidates, there may be occasions when expertise is ‘bought in’. This is consistent with the desire to enable candidates, wherever feasible, to capitalise on their strengths in terms of practical activities. Candidates may be assessed in settings outside the Centre by teachers/coaches other than those within the Physical Education department of the Centre. **The assessment of practical activities is however, the responsibility of the Head of Physical Education who must not only oversee the process but ensure that there is internal standardisation across the Centre's assessments and all the staff involved in the assessments.**

At AS these activities must remain within the parameter of being from two different activity categories. **The activity which candidates are assessed in at A2 must be one of the activities they were assessed in as part of the AS unit G452** (Acquiring, Developing and Evaluating Practical Skills in Physical Education). Coursework is set and marked by the Centre and externally moderated by OCR

Final marks are submitted to OCR as follows: -

AS - A minimum of one activity to be assessed and submitted by March 31st. Performance assessments in seasonal activities may be submitted by the final coursework submission date: May 15th. The assessment of seasonal activities submitted by 15th May **must** be accompanied by video evidence.

A2 - by March 31st in the year of examination.

For some physical activities, particularly seasonal activities (i.e. cricket, tennis, track and field activities) it may be necessary to assess them during the summer term of the AS year or the autumn term of the A2 year. The pattern of coursework assessment is as follows:-

AS Unit G452 - Acquiring, Developing and Evaluating Practical Skills in Physical Education.

Candidates will be assessed in:

1. Performing two chosen activities from two different activity profiles

or

2. Performing one chosen activity and coaching/leading one chosen activity from two different activity profiles

or

3. Performing one chosen activity and officiating one chosen activity in two different activities.

30% of the AS marks

and

Evaluating and planning for the improvement of performance.

10% of the AS marks.

A2 Unit G454 - The improvement of effective performance and critical evaluation of practical activities in Physical Education.

Candidates will be assessed in:

1. Performing one chosen activity from one of the activity profiles

or

2. Coaching/Leading one chosen activity from one of the activity profiles

or

3. Officiating one chosen activity from one of the activity profiles

20% of the A2 marks

and

The evaluation, appreciation and improvement of performance.

10% of the A2 marks

1.4 Moderation

Moderation is by means of cluster groups based on geographical distribution. The process is to ensure that assessments are standardised across all Centres and that every candidate is treated fairly.

A sample of a Centre's candidates will be identified by the Moderator and asked to attend a cluster moderation meeting. Candidates may be moderated in the activities in which they have been assessed, but may also be asked to take part in other activities to ensure viable numbers for the standardisation exercise. Cluster moderations usually last for a day, but Centres can request that, where the programme of activities permits, candidates attend for only part of the day. Candidates should be aware that moderation is part of the examination process and that they should prepare themselves adequately for the process. Candidates who are requested to attend by the moderator are required to do so. Candidates who fail to attend moderation without prior permission from the moderator may be deemed to be absent from that unit and awarded a zero score.

All final assessments will be supported by video evidence. Centres are required to have video evidence of a sample of their candidates across the range of marks (top, middle and bottom) for **each** activity assessed. This video evidence should include:

For AS:

- the selection and application of acquired and developed skills. Candidates are videoed taking part in performance, coaching/leading or officiating assessment situations.
- Evaluation and planning for the improvement of performance. Candidates are videoed responding together with the performance they have observed.

For A2:

- the performance of a range of basic and advanced acquired and developed skills in an authentic context. Candidates are videoed taking part in performing, coaching/leading or officiating assessment situations.
- Evaluation, appreciation and the improvement of performance. Candidates are videoed responding together with footage of the performance they have observed.

The video evidence should clearly identify candidates and enable them to be linked to the assessment documentation.

Centres should ensure that candidates included in the video evidence can be clearly identified and linked to the assessment sheets. This can be achieved by the use of numbered bibs together with a commentary or accompanying documentation. The video evidence should relate to the assessment criteria for the activity concerned.

For the oral response at both AS and A2 the video evidence should include some footage of the performance which the candidate has observed.

For assessments submitted by 31st March video evidence should be retained by the centre until requested by the moderator. For assessments submitted by 15th May the video evidence should accompany the assessments.

Only VHS, DVD or CD ROM format will be accepted.

1.5 Internal Standardisation

Each Centre is required to standardise assessment across different activities by different members of staff to ensure that all candidates have been judged against the same standards and are therefore fairly assessed. Usually the Head of Department/A Level PE Co-ordinator will be responsible for ensuring that the assessments are standardised and accurate, particularly where more than one teacher has been involved in the assessment.

1.6 Minimum Coursework Requirements

If a candidate submits no work for a coursework unit, then the candidate should be indicated as being absent from that unit. If a candidate completes any work at all for a coursework unit then the work should be assessed according to the criteria and marking instructions and the appropriate mark awarded, which may be 0 (zero).

1.7 Special Arrangements

For candidates who are unable to complete the full assessment or whose performance may be adversely affected through no fault of their own, teachers should consult the *Inter-Board Regulations and Guidance Booklet for Special Arrangements and Special Consideration*. In such cases advice should be sought from OCR as early as possible during the course.

All candidates must fulfil the rubric of the specification. Candidates with special needs could have an activity adapted but this must allow candidates to be assessed for the same skills as other candidates. It is the responsibility of the Centre to propose adaptation to an activity which must be approved by OCR before commencement of the course.

1.8 Authentication

As with coursework, the teachers must verify that the work carried out for assessment is the candidate's own work. Sufficient work must be carried out under direct supervision to allow the teacher to authenticate the coursework marks with confidence.

1.9 Submission of log books for Moderation

Log books completed for performance activities, coaching/leading or officiating must be completed by 31st March. Centres will be notified by moderators which of these log books they need to submit.

1.10 Special Activity Submission Criteria

Centres may wish to enter candidates for an activity which does not feature in those already described in Section 1.2 in order for candidates to capitalise on their areas of expertise.

Centres should ensure that their submissions are sent to OCR's Physical Education Subject Officer by 15th October in the academic year of assessment.

The submission for the activity should meet the following criteria:

- the activity must have a national governing body;
- the activity must link with one of the eleven activity profiles;
- the activity is required to comply with the existing generic criteria for the activity profile it links to for AS/A2;
- contain details of the assessment criteria specific to the activity;
- contain details of standardisation if it takes place away from the Centre;
- contain details of the conditioned competitive situations and the effective performance situation;
- comply with BAALPE's safety recommendations;

If accepted the activity will be available for use by the candidate or candidates identified in the submission and for that academic year only by the centre submitting.

If Centres are unsure that an activity meets these criteria, they can request advice from OCR.

OCR reserves the right to refuse, amend or modify a submission.

2. Unit G452: Acquiring, developing and evaluating practical skills in Physical Education

2.1 Introduction

Physical Education hinges on physical performance and its significance is acknowledged within Arnold's first dimension where the intrinsic value of Physical Education as an experience is recognised. Module G452 focuses on the acquisition and development of physical skills, recognising that they can be performed in isolation, but usually in combination with others. Skills need to be practised in order to be performed as specific movements or activities, which are then repeated consistently, with precision. Module G452 links the physical activities with both Key Stage 4 where pupils 'develop and apply advanced skills and techniques' and to GCSE Physical Education where candidates 'perform increasingly advanced techniques' and apply them in increasingly demanding situations.

Once specific movements or actions can be repeated consistently it enables candidates to adapt them and ultimately perform them autonomously to meet the needs of a variety of conditions and environments within the context of Unit of Assessment G454.

Candidates are able to draw on and apply subject matter from Module G451 which is appropriate and relevant to the selected activities pursued. This application should consist of a synthesis of theory and practice as reflected in the aims and objectives of the specification together with exemplars to illustrate links between physical performance and theoretical study.

Centres should devise programmes that enable candidates to experience and develop all aspects of their practical activities. Candidates should also experience different roles e.g. different playing positions in invasion games; singles and doubles in racquet games. They should also gain experience in coaching/leading the activities so as to develop their understanding and appreciation of the coaching points of skills, and the application of tactics/compositional ideas, associated with their chosen activities. In addition, they should experience the role of officiating so as to develop their knowledge, understanding and ability to apply the rules, regulations, conventions and codes of conduct relevant to their activities.

Activities will be set in suitably demanding contexts which show progression from National Curriculum/GCSE and which are appropriate for the ability of the candidate.

Candidates should have an understanding of the short and long-term health and fitness benefits of the activity as well as an awareness of the opportunities for participation and progression both locally and nationally.

In the roles of performing, coaching/leading and officiating candidates should be able to explain the factors which make for an effective and efficient performance through the development of their knowledge and understanding of the relationship between skill, strategy/composition and fitness.

The understanding of the relationship between skill, strategy/composition and fitness will be further enhanced as candidates develop and improve:

- the range, difficulty and quality of their basic and advanced skills. These will be implemented with greater consistency in terms of precision, control and fluency in situations that are both complex and demanding;
- their ability to use tactics, strategies/compositional ideas through an understanding of key principles underpinning success in the activity and their effective selection and use of advanced strategic/choreographic or organisational concepts in situations that are increasingly complex and demanding;
- their capacity to perform effectively by maintaining and developing their physical fitness and developing their knowledge and understanding of the effects of physical and mental preparation on performance as well as their ability to prepare and train mentally and physically for physical activity.

2.2 Unit Content

The candidate must follow a minimum of two activities from two of the following ten different activity profiles.

Activity profiles

CATEGORY	ACTIVITY	ABBREVIATION
ATHLETIC	CROSS COUNTRY	CC
	DRAGON BOAT RACING	DBR
	OLYMPIC WEIGHTLIFTING	OW
	RACE WALKING	RaW
	ROWING & SCULLING	Rw
	TRACK & FIELD	Ath
	TRACK CYCLING	TC
	TRIATHALON	Tri
COMBAT	BOXING	Bxg
	FENCING	Fen
	JUDO	Ju
	KARATE (non-contact)	Kar
	TAE KWON-DO	TKD
	WRESTLING	Wr

DANCE	ARTISTIC ROLLER SKATING	RS
	BALLET	Bal
	BALLROOM DANCING	BD
	EDUCATIONAL DANCE	Da
	FOLK DANCING	FD
	ICE DANCE	ID
	IRISH DANCING	IrD
	TAP DANCE	TaD

GYMNASTIC	DIVING	Div
	GYMNASTICS	Gym
	ICE (FIGURE) SKATING	ISk
	RHYTHMIC GYMNASTICS	Rg
	SPORTS ACROBATICS	SAw
	TRAMPOLINING	Tr

INVASION GAMES	ASSOC FOOTBALL	Af
	BASKETBALL	BAS
	FIELD HOCKEY	Ho
	GAELIC FOOTBALL	GF
	HANDBALL	Hb
	HURLING	Hu
	ICE HOCKEY	IH
	INLINE SKATER HOCKEY	ISH
	KORFBALL	Kor
	LACROSSE	Lac
	NETBALL	Ne
	POLO	Pol
	ROLLER HOCKEY	RH
	RUGBY LEAGUE	RL
	RUGBY UNION	RU
	WATER POLO	WP

NET/WALL GAMES	BADMINTON	Bad
	SQUASH	Sq
	TABLE TENNIS	Tt
	TENNIS	Te
	VOLLEYBALL	Vo

STRIKING/FIELDING GAMES	BASEBALL	Bb
	CRICKET	Cr
	ROUNDERS	Ro

TARGET GAMES	ARCHERY	Ar
	FLAT GREEN BOWLING	Gb
	GOLF	Go

OUTDOOR & ADVENTUROUS	CANOEING	Ca
	EQUESTRIAN (Cross Country)	HRc
	EQUESTRIAN (Dressage)	HRd
	EQUESTRIAN (Eventing)	HRe
	EQUESTRIAN (Show Jumping)	HRs
	KAYAKING	Ka
	MOUNTAIN BIKING	Mb
	MOUNTAIN WALKING	Mw
	ORIENTEERING	Or
	ROCK CLIMBING	Rc
	SAILING	Sa
	SKIING	Sk
	SNOWBOARDING	Sno
	SUB-AQUA DIVING	SAD
	SURFING	Sur

SWIMMING	COMPETITIVE SWIMMING	Sw
	LIFE SAVING	Ls

SAFE & EFFECTIVE EXERCISE	CIRCUIT TRAINING	CT
---------------------------	------------------	----

2.3 Unit Assessment

The candidate's practical performance, knowledge and understanding is assessed in Unit G452. The candidate is assessed in the selection and application of acquired and developed skills in two activities, together with evaluation and planning for improvement. The two activities are each assessed out of 30 marks. The evaluation and planning for improvement is assessed out of 20 marks.

Candidates will be assessed in:

1. Performing two chosen activities from two **different activity profiles** and Evaluating and Planning for the improvement of performance.

OR

2. Performing one chosen activity and coaching/leading one chosen activity from **two different activity profiles** together with Evaluating and Planning for the improvement of performance.

OR

3. Performing one chosen activity and officiating one chosen activity in **two different activities** together with Evaluating and Planning for the improvement of performance.

The Selection and Application of Acquired and Developed Skills

There are three different pathways in which candidates can be assessed in the selection and application of acquired and developed skills. These are:

1. Performance
2. Coaching/leading
3. Officiating

1. Performance

Candidates are assessed in their ability to select and perform skills consistently, precisely and with control and fluency in an applied skill environment.

These acquired and developed skills are assessed in conditioned, competitive situations which generate tasks of suitable pitch and challenge. This ensures that candidates are able to select the appropriate skills whilst also performing them repetitively and consistently as specific movements, and adapting them to suit a variety of situations. These tasks should:

- aim to improve the candidate's performance using tasks of suitable pitch and challenge within authentic contexts;

- place emphasis on the appropriate basic and advanced acquired and developed skills and pressurise candidates by utilising features such as restricting the number of players, space and range of skills;
- identify the candidate's level of autonomy whilst providing the range of pitch and challenge to enable ability differentials to be displayed;
- develop the candidate's physical and mental fitness.

The conditioned, competitive situations should generate tasks of appropriate pitch and challenge which:

- focus on the range of basic and advanced applied and acquired skills to be assessed;
- are structured to allow candidates to develop basic tactical/choreographical/compositional awareness;
- may be conditioned, in which acquired and developed skills are assessed whilst applying the normal rules/regulations and codes of practice;
- enable candidates to be placed in a rank order in terms of ability.

Candidates should be able to:

- perform a range of basic and advanced acquired and developed skills in conditioned, competitive situations which generate tasks of suitable pitch and challenge;
- select and apply skills and tactics/choreographic/compositional ideas in conditioned, competitive situations thereby demonstrating their understanding of the perceptual requirements of the activity;
- demonstrate an understanding and application of the relevant rules, regulations and code of practice of the activity;
- demonstrate a knowledge and understanding of the fitness and health benefits of the activity.

Conditioned Competitive Situations

In some activities the Conditioned Competitive Situations are prescribed. For example:

Activity	Conditioned Competitive Situation
Gymnastics	4 cross-box vaults A movement sequence
Trampolining	A 10-contact routine
Dance	3, one-minute solo choreographed dances
Mountain Walking	A two-day, 14 hour journey

2. Coaching/leading

Candidates are assessed in coaching/leading an activity (this must be from a different activity profile to the activity their performance has been assessed in).

Candidates are assessed in their ability to lead safe, purposeful and enjoyable sporting and physical recreational activities whilst exhibiting motivation, responsibility, control and confidence. These skills, abilities and qualities are assessed in authentic contexts which generate tasks of suitable pitch and challenge thus ensuring that candidates are able to select the appropriate coaching/leading methodology whilst also performing repetitively and consistently, adapting and adjusting to suit a variety of situations.

The tasks generated aim to improve the candidate's coaching/leading performance and centres should devise their own tasks of suitable pitch and challenge within authentic contexts. These tasks should place emphasis on the appropriate developed skills, abilities and qualities and challenge candidates. By working with primary school children in Top Sport/ Dragon Sport sessions, working with disabled groups, working with youth groups, suitable tasks can be generated. The tasks generated should identify the candidate's level of autonomy whilst providing the range of pitch and challenge to enable ability differentials to be displayed.

The authentic contexts should generate tasks of appropriate pitch and challenge which:

- focus on the range of applied and acquired skills, abilities and qualities to be assessed;
- enable candidates to be placed in a rank order in terms of ability;
- be structured to allow candidates to develop their coaching/leadership skills.

Candidates should be able to:

- Deliver safe, purposeful and enjoyable coaching/leading sessions which generate tasks of suitable pitch and challenge;
- demonstrate a range of basic and advanced acquired and developed skills in an authentic context which generates tasks of suitable pitch and challenge;
- demonstrate competence in organisational skills related to the planning and delivery of sessions;
- demonstrate appropriate communication skills;
- demonstrate an understanding and appreciation of health and safety procedures;
- implement risk assessment procedures;
- demonstrate a knowledge and understanding of the fitness and health aspects of the activity;
- evaluate sessions delivered and plan for improvement;
- demonstrate an awareness of Child Protection issues and procedures;
- operate the principle of inclusion in their sessions.

Candidates will keep a detailed log which should include:

- i) records of their coaching/leading activities over a three month period;
- ii) a scheme of work which identifies progression and has a minimum of ten hours of session plans together with appropriate evaluations of the sessions and risk assessments;
- iii) a personal video record of a minimum of forty minutes of coaching/leading;
- iv) details of health and safety issues relevant to the activity;
- v) details of child protection procedures in operation for the activity together with evidence of appropriate CRB clearance for the candidate;
- vi) evidence of the candidate's appropriate first aid qualification;
- vii) details of the fitness and health benefits of the activity and of coaching/leading the activity.

3. Officiating

Candidates are assessed in officiating an activity (this must differ from the activity their performance has been assessed in).

Candidates are assessed in their ability to officiate in safe, purposeful and enjoyable sporting and recreational activities whilst exhibiting responsibility, control and confidence. These skills, abilities and qualities are assessed in authentic contexts which generate tasks of suitable pitch and challenge thus ensuring that candidates are able to select the appropriate officiating style whilst also performing repetitively and consistently, adapting and adjusting to suit a variety of situations.

The tasks generated aim to improve the candidate's officiating performance and centres should devise their own tasks of suitable pitch and challenge within authentic contexts. These tasks should place emphasis on the appropriate developed skills, abilities and qualities and challenge candidates. By utilising opportunities in primary school sports, local junior sports, lower secondary school sports, inter-form sports, inter-school sports, working with youth groups, suitable tasks can be generated. The tasks generated should identify the candidate's level of autonomy whilst providing the range of pitch and challenge to enable ability differentials to be displayed.

The authentic contexts should generate tasks of appropriate pitch and challenge which:

- Focus on the range of applied and acquired skills, abilities and qualities to be assessed;
- Enable candidates to be placed in a rank order in terms of ability;
- Be structured to allow candidates to develop their officiating.

Candidates should be able to:

- Officiate safe, purposeful and enjoyable sessions;
- Officiate in sessions which generate tasks of suitable pitch and challenge enabling candidates to display a range of basic and advanced acquired and developed skills;
- Perform a range of basic and advanced acquired and developed skills in an authentic context which generates tasks of suitable pitch and challenge;

- Demonstrate an applied knowledge and understanding of the rules/regulations of the activity;
- Demonstrate appropriate communication skills;
- Demonstrate an understanding and appreciation of health and safety procedures;
- Implement risk assessment procedures;
- Demonstrate an awareness of child protection issues and procedures.
- Demonstrate a knowledge and understanding of the fitness and health aspects of the activity;
- Evaluate sessions officiated and plan for improvement.

Candidates will keep a detailed log which:

- Records their officiating activities over a three month period with personal evaluations of sessions officiated.
- Has a minimum of four qualified assessor evaluations of the sessions officiated.
- Has evidence of risk assessments undertaken,
- Has a personal video record of a minimum of forty minutes of officiating.
- Details health and safety issues relevant to the activity.
- Details child protection procedures in operation for the activity, together with appropriate CRB clearance for the candidate.
- Details the fitness and health benefits of the activity and of officiating the activity.

The Evaluation and planning for improvement

Candidates will observe a live performance by another candidate in one of their own assessed performance activities. Candidates will then consider the factors that make for an effective and efficient performance in this activity. Candidates will critically evaluate:

- the quality of the acquired and developed skills;
- the success of the selection and application of skills, tactics/compositional ideas;
- the health and fitness benefits of the activity observed.

Candidates will give a detailed evaluative response using appropriate technical language, in which they will discuss:

- the strengths of the performance observed in relation to skills, tactics/compositional ideas and fitness;
- the weaknesses of the performance observed in relation to skills, tactics/compositional ideas and fitness;
- areas of the performance they would prioritise for improvement;
- an action plan to improve one of the major weaknesses identified to include detailed coaching points and detailed progressive practices together with a timescale for the plan;
- opportunities locally and nationally for performers to participate and progress in the activity;
- the health and fitness benefits of the activity observed.

The candidate will observe another candidate performing the activity and NOT coaching/leading or officiating the activity.

3 Performance - Activity Profiles and Assessment Criteria

3.1 Athletic Activities

1. Cross Country (CC)
2. Dragon Boat Racing (DBR)
3. Olympic Weightlifting (OW)
4. Race Walking (RaW)
5. Rowing and Sculling (Rw)
6. Track Cycling (TC)
7. Track and Field Athletics (Ath)
8. Triathlon (Tri)

Athletic Activities – Generic Criteria

Performance

The candidate is assessed in:

- The performance of a range of basic and advanced skills
- The selection and application of skills and tactics
- Physical and mental fitness
- The understanding and application of rules

The assessment should take place in conditioned competitive situations where tasks of appropriate pitch and challenge enable candidates to:

- Demonstrate a range of basic and advanced skills
- Demonstrate appropriate tactical awareness
- Demonstrate an understanding and application of rules
- Be placed in rank order in terms of ability

The level of success of their basic and advanced skills will be based on the accurate replication of actions, phases and sequences.

The level of success in appropriate tactical awareness will be based on performance at maximum levels.

These assessment phases are used in conjunction with the following assessment criteria for the tasks of appropriate pitch and challenge in authentic contexts.

Band 1 (25-30)

The candidate demonstrates a very high level of acquired and developed skills that show a consistently high standard of accuracy, control and fluency under competitive pressure.

There is consistent successful selection and application of a wide range of advanced techniques which, under competitive pressure maintain their accuracy, fluency and control.

A wide range of appropriate strategies and tactics are successfully and consistently used by the candidate demonstrating an excellent understanding of the perceptual requirements of the activity.

The overall performance in the competitive situation is excellent and indicative of high levels of learning and understanding.

The candidate demonstrates excellent physical and mental fitness.

The candidate demonstrates an excellent understanding and application of the rules/regulations of the activity.

Band 2 (19-24)

The candidate demonstrates a high level of acquired and developed skills that show a consistently high standard of accuracy, control and fluency under competitive pressure.

There is consistent successful selection and application of a range of advanced techniques which, under competitive pressure maintain their accuracy, fluency and control.

A range of appropriate strategies and tactics are successfully and consistently used by the candidate demonstrating a good understanding of the perceptual requirements of the activity.

The overall performance in the competitive situation is very good and indicative of good levels of learning and understanding.

The candidate demonstrates good physical and mental fitness.

The candidate demonstrates a good understanding and application of the rules/regulations of the activity.

Band 3 (13-18)

The candidate demonstrates a sound level of acquired and developed skills that show a consistently good standard of accuracy, control and fluency under competitive pressure.

There is successful selection and application of a range of advanced techniques which, under competitive pressure maintain their accuracy, fluency and control.

A limited range of appropriate strategies and tactics are successfully used by the candidate demonstrating a sound understanding of the perceptual requirements of the activity.

The overall performance in the competitive situation is good and indicative of sound levels of learning and understanding.

The candidate demonstrates sound physical and mental fitness.

The candidate demonstrates a sound understanding and application of the rules/regulations of the activity.

Band 4 (7-12)

The candidate demonstrates a limited level of acquired and developed skills that show some accuracy, control and fluency under competitive pressure.

There is successful selection and application of advanced techniques which, under competitive pressure usually maintain some accuracy, fluency and control.

Some appropriate strategies and tactics are successfully used by the candidate demonstrating a limited understanding of the perceptual requirements of the activity.

The overall performance in the competitive situation is limited, inconsistent and indicative of limited learning and understanding.

The candidate demonstrates limited physical and mental fitness.

The candidate demonstrates limited understanding and application of the rules/regulations of the activity.

Band 5 (0-6)

The candidate demonstrates a poor level of acquired and developed skills that show little accuracy, control and fluency under competitive pressure.

There is an attempt to select and apply advanced techniques which, under competitive pressure maintain little accuracy, fluency and control.

- Appropriate strategies and tactics are rarely used by the candidate demonstrating a poor understanding of the perceptual requirements of the activity.
- The overall performance in the competitive situation is poor, inconsistent and indicative of limited learning and understanding
- The candidate demonstrates inadequate levels of physical and mental fitness.
- The candidate demonstrates little understanding and application of the rules/regulations of the activity.

1. Cross Country

The candidate is assessed performing the acquired and developed skills of Cross Country.

The focus of the tasks will be:

Running over different types of:

- terrain
- surfaces
- distances

The level of success of the acquired and developed skill is measured through the movement phases identified below:

- Posture
- Leg action
- Arm action
- Head carriage
- Overall efficiency

These assessment phases are used in conjunction with the generic criteria for Athletic activities.

The following are given as suggestions/exemplars of conditioned competitive situations and are not seen as being prescriptive. Centres may devise their own conditioned competitive situations.

1. Longer distance 'runs' of 5km or longer, focusing on sustaining technique and pace.
2. Shorter distance 'runs' of 2km or less, focusing on maintenance and control of technique at speed.
3. Shorter distance endurance runs focusing on finishing.

These should be carried out over different types of terrain and surfaces.

2. Dragon Boat racing

The candidate is assessed performing the acquired and developed skills of Dragon Boat racing.

The focus of the tasks will be:

- Sprint events
- Endurance events

The candidate is assessed in sprint **and** endurance events in a standard international designed boat conforming to BDA and European regulations.

The level of success of the acquired and developed skill is measured through the movement phases identified below:

1. Sprint events – 250/500/1000 metres

Starting techniques

Paddling techniques

- The catch
- Compression
- The finish
- The recovery
- Variations in stroke technique
- Stroke rating

2. Endurance events – 6,000-10,000 metres

- Starting position and technique
- Development of recovery time
- Assessing the environmental conditions (lake/river) in relation to tactics.

3. Demonstrating their knowledge and understanding of the equipment necessary for Dragon Boat racing through its preparation for use.

Boat.

- Role of racing bars
- Role of drummer(traditional/active)
- Standard European dimensions
- Weight.

Paddles.

- Length of paddle in relation to each individual
- Degree of stiffness of blade in relation to each individual
- Use of Helm blade.

These assessment phases are used in conjunction with the generic assessment criteria for Athletic activities.

The following are given as suggestions/exemplars of conditioned competitive situations and are not seen as being prescriptive. Centres may devise their own conditioned competitive situations.

Sprints – starts, short sprint paddles 16-20 strokes efforts

Endurance – part race distances.

The requirements of the number of paddlers required in relation to environmental conditions especially the depth of water/tactics should be taken into account.

3. Olympic Weightlifting

The candidate is assessed performing the acquired and developed skills of Olympic weightlifting.

The focus of the tasks will be:

- Clean and Jerk
- Snatch

The level of success of the acquired and developed skill is measured through the movement phases identified below:

Clean and Jerk

- Safety of lifting area and placement of bar
- Preparation phase
- Starting position
- First pull
- Second pull
- Lifting catching phase
- Preparation for the jerk
- The Jerk
- Recovery catching phase
- Placement of bar
- Overall efficiency of the lift

The snatch

- Safety of lifting area and placement of the bar
- Preparation phase
- Starting position
- First pull
- Second pull
- Catching of the bar
- The snatch
- Recovery phase
- Placement of bar
- Overall efficiency of the lift

These assessment phases are used in conjunction with the generic criteria for Athletic activities.

4. Race Walking

The candidate is assessed performing the acquired and developed skills of Race Walking.

The focus of the tasks will be:

- Race Walking

The level of success of the acquired and developed skill is measured through the movement phases identified below:

- Posture
- Leg action
- Foot action
- Arm action
- Head carriage
- Maintenance of contact with the ground
- Overall efficiency

These assessment phases are used in conjunction with the generic criteria for Athletic activities.

The following are given as suggestions/exemplars of conditioned competitive situations and are not seen as being prescriptive. Centres may devise their own conditioned competitive situations.

1. Longer distance 'race walk' of 5km or longer, focusing on sustaining technique and pace.
2. Shorter distance 'race walk' of 2km or less, focusing on maintenance and control of technique at speed.

5. Rowing and Sculling

The candidate is assessed performing the acquired and developed skills of Rowing or Sculling.

The candidate will be assessed in:

Rowing in either sprint or 'head race' events

or

Sculling in either sprint or 'head race' events

Sprint events - 2000 metres

'Head race' – 2500 - 6000 metres

The focus of the tasks will include:

- Sculling strokes
- Rowing on stroke side
- Paddling with square blades
- Rowing on bow side

Sprint Events

The focus will be on starts, technique and race tactics.

Head race Events

The focus will be on 'Rolling starts', positioning on the river, technique and race tactics.

The level of success of the acquired and developed skill is measured through the movement phases identified below:

- Leg position/ action
- Body position/action
- Arm action/position
- Posture
- Overall efficiency
- Grip/hand placement on oar
- Angle of oar/entry
- Action in relation to boat
- Recovery

These assessment phases are used in conjunction with the generic criteria for Athletic activities.

The following are given as suggestions/exemplars of conditioned competitive situations and are not seen as being prescriptive. Centres may devise their own conditioned competitive situations.

Sprints – starts, short sprints e.g. 20 stroke efforts

Heads – part race distances

6. Track Cycling

The candidate is assessed performing the acquired and developed skills of Track cycling.

The focus of the tasks is:

Two acquired and developed skills, these being selected from the following event areas:

- Track sprint;
- Pursuit;
- Time trial.

The candidate's assessed events should be clearly identified on the assessment sheet.

The level of success of the acquired and developed skill is measured through the movement phases identified below:

Track sprint

- Start position
- Posture
- Position on track
- Leg action
- Overall efficiency

Pursuit

- Posture
- Pacing
- Leg action
- Tactics
- Overall efficiency

Time trial

- Posture
- Pacing
- Leg action
- Overall efficiency

These assessment phases are used in conjunction with the generic criteria for Athletic activities.

7. Track and Field Athletics.

The candidate is assessed performing the acquired and developed skills of Track and Field athletics.

The focus of the tasks will be:

Two acquired and developed skills, these being selected from **two** of the following event areas:

- Track;
- Jumps;
- Throws.

The level of success of the acquired and developed skill is measured through the movement phases identified below:

Track events

- Posture
- Leg action
- Arm action
- Head carriage
- Overall efficiency

Jumping events

- Approach
- Take off
- Flight
- Landing
- Overall efficiency

Throwing events

- Initial stance, grip and preparation
- Travel and trunk position
- Throwing action
- Release
- Overall efficiency

These assessment phases are used in conjunction with the generic criteria for Athletic activities.

The following are given as suggestions/exemplars of conditioned competitive situations and are not seen as being prescriptive. Centres may devise their own conditioned competitive situations.

Track Events: Shorter distance sprints, focusing on starts and technique.
Shorter distance sprints, focusing on bend running, lane position.
Sprint work focusing on crossing the finishing line.

Field Events: Standing throws
(Throws) Throws with different weighted implements.

Field Events: Standing jumps/restricted run-ups.
(Jumps)

8. Triathlon

The candidate is assessed performing the acquired and developed skills of the Triathlon.

The focus of the tasks will be:

- swimming;
- cycling;
- running.

The level of success of the acquired and developed skill is measured through the movement phases identified below:

1. Swimming:
 - Body position
 - Arm action
 - Leg action breathing
 - Overall efficiency
2. Cycling :
 - Body position
 - Head carriage
 - Arm action
 - Leg action
 - Overall efficiency
3. Running:
 - Posture
 - Head carriage
 - Arm action
 - Leg action
 - Overall efficiency

These assessment phases are used in conjunction with the generic assessment criteria for Athletic activities.

The following are given as suggestions/exemplars of conditioned competitive situations and are not seen as being prescriptive. Centres may devise their own conditioned competitive situations.

1. Swimming – Longer distances to focus on pacing and technique
Shorter distances to focus on change over
2. Cycling – Longer distances to focus on pacing and technique
Shorter distances to focus on change over
3. Running – Longer distance endurance runs focusing on pacing and techniques
Shorter distance endurance runs focussing on finishing.

3.2 Combat Activities

1. Boxing (Bxg)
2. Fencing (Fen)
3. Judo (Ju)
4. Karate (Non-contact) (Kar)
5. Tae Kwon Do (TKD)
6. Wrestling (Wr)

Combat activities- Generic criteria

Performance

The candidate is assessed in:

The performance of a range of basic and advanced skills

The selection and application of skills and tactics

Physical and mental fitness

The understanding and application of rules/conventions.

The assessment should take place in conditioned competitive situations where tasks of appropriate pitch and challenge enable candidates to:

Demonstrate a range of basic and advanced skills

Demonstrate appropriate tactical awareness

Demonstrate an understanding and application of rules/conventions

Be placed in rank order in terms of ability.

The level of success of their basic and advanced skills will be based on movement phases appropriate to the activity itself.

The level of success in appropriate tactical awareness will be based on:

- Attacking
- Defending

These assessment phases are used in conjunction with the following assessment criteria for the tasks of appropriate pitch and challenge in authentic contexts.

Band 1 (25-30)

The candidate demonstrates a very high level of acquired and developed skills that show a consistently high standard of accuracy, control and fluency under competitive pressure.

There is consistent successful selection and application of a wide range of advanced techniques which, under competitive pressure maintain their accuracy, fluency and control.

A wide range of appropriate strategies and tactics are successfully and consistently used by the candidate demonstrating an excellent understanding of the perceptual requirements of the activity.

The overall performance in the competitive situation is excellent and indicative of high levels of learning and understanding.

The candidate demonstrates excellent physical and mental fitness.

The candidate demonstrates an excellent understanding and application of the rules/regulations/conventions of the activity.

Band 2 (19-24)

The candidate demonstrates a high level of acquired and developed skills that show a consistently high standard of accuracy, control and fluency under competitive pressure.

There is consistent successful selection and application of a range of advanced techniques which, under competitive pressure maintain their accuracy, fluency and control.

A range of appropriate strategies and tactics are successfully and consistently used by the candidate demonstrating a good understanding of the perceptual requirements of the activity.

The overall performance in the competitive situation is very good and indicative of good levels of learning and understanding.

The candidate demonstrates good physical and mental fitness.

The candidate demonstrates a good understanding and application of the rules/regulations/conventions of the activity.

Band 3 (13-18)

The candidate demonstrates a sound level of acquired and developed skills that show a consistently good standard of accuracy, control and fluency under competitive pressure.

There is successful selection and application of a range of advanced techniques which, under competitive pressure maintain their accuracy, fluency and control.

A limited range of appropriate strategies and tactics are successfully used by the candidate demonstrating a sound understanding of the perceptual requirements of the activity.

The overall performance in the competitive situation is good and indicative of sound levels of learning and understanding.

The candidate demonstrates sound physical and mental fitness.

The candidate demonstrates a sound understanding and application of the rules/regulations/conventions of the activity.

Band 4 (7-12)

The candidate demonstrates a limited level of acquired and developed skills that show some accuracy, control and fluency under competitive pressure.

There is successful selection and application of advanced techniques which, under competitive pressure usually maintain some accuracy, fluency and control.

Some appropriate strategies and tactics are successfully used by the candidate demonstrating a limited understanding of the perceptual requirements of the activity.

The overall performance in the competitive situation is limited, inconsistent and indicative of limited learning and understanding.

The candidate demonstrates limited physical and mental fitness.

The candidate demonstrates limited understanding and application of the rules/regulations/conventions of the activity.

Band 5 (0-6)

The candidate demonstrates a poor level of acquired and developed skills that show little accuracy, control and fluency under competitive pressure.

There is an attempt to select and apply advanced techniques which, under competitive pressure maintain little accuracy, fluency and control.

Appropriate strategies and tactics are rarely used by the candidate demonstrating a poor understanding of the perceptual requirements of the activity.

The overall performance in the competitive situation is poor, inconsistent and indicative of limited learning and understanding

The candidate demonstrates inadequate levels of physical and mental fitness.

The candidate demonstrates little understanding and application of the rules/regulations/conventions of the activity.

Boxing

The candidate is assessed performing the acquired and developed skills of Boxing.

The focus of the tasks will include:

- Straight punching
- Single punching
- Combination punching
- Use of feet, arms and trunk to defend
- Guard
- Weight distribution

The level of success of the acquired and developed skills is measured through the following movement phases:

- Attack – stance, guard, footwork, balance.
- Defence – stance, guard, footwork, balance.

These assessment phases are used in conjunction with the generic criteria for Combat activities.

Fencing

The candidate is assessed in performing the acquired and developed skills of Fencing.

The focus of the tasks will be on **two** acquired and developed skills, these being selected from two of the following disciplines:

- Foil
- Epee
- Sabre

The focus of these acquired and developed skills will include:

- Beat attack
- Disengage
- Lunge
- Parry
- Parry sixte

The level of success of the acquired and developed skills is measured through the following movement phases:

- Attacking – preparation, execution, recovery, result, overall efficiency.
- Defending - preparation, execution, recovery, result, overall efficiency.

These assessment phases are used in conjunction with the generic assessment criteria for Combat activities.

Judo

The candidate is assessed performing the acquired and developed skills of Judo.

The focus of the tasks will include:

- Goshi
- Morote Seoi Nage
- Harai Goshi
- Tsuru Komi Goshi
- Kata Game
- Kamishio Gatame
- Mune Gatame
- Kesa Gatame
- Soto Gari
- Uchi Gari
- Ko-uchi Gari
- Uchi Mata

The level of success of the acquired and developed skills is measured through the following movement phases:

Defending

- Entry
- Controlling opponent
- Execution
- Completion/effectiveness
- Overall efficiency

Attacking

- Grip
- Set up, breaching balance
- Entry, balance, timing
- Throw, completion, effectiveness
- Overall efficiency

These assessment phases are used in conjunction with the generic assessment criteria for Combat activities.

The following are suggestions/exemplars of conditioned competitive situations and are not seen as being prescriptive. Centres may devise their own conditioned competitive situations. Contests are limited in terms of:

- Techniques permitted;
- Mat area;
- Time allowed;
- The limitations imposed should enable candidates to focus on their:
 - Groundwork techniques
 - Throwing techniques

In conjunction with the associated tactics and principles.

Karate (Non contact)

The candidate is assessed in the acquired and developed skills of Karate (non-contact)

The focus of the tasks will include:

- Kihon – a range of basic techniques including basic combinations;
- Kata – formal exercise sequence;
- Kumite – sparring.

The level of success of the acquired and developed skill is measured through the movement phases identified below:

- Kihon – speed, form, focus, power, smoothness of application, attitude;
- Kata – Speed, form, focus, smoothness of application, attitude;
- Kumite - Speed, form, focus, smoothness of application, timing, distance, safe control of techniques.

Candidates will be expected to demonstrate their knowledge and understanding of:

- Rules of dojo etiquette;
- The dojo code;
- The general code of conduct for Karateka;
- The procedures for kata performance;
- The rules and procedures for basic sparring;
- Definition of Karate;

- History of Karate.

These phases will be used in conjunction with the generic assessment criteria for Combat activities.

The following conditioned competitive situations are Shotokan based and could be appropriately adapted for Goju Ryu, Shito Ryu or Wado Ryu etc. Most of the terms are generic and will be understood by qualified instructors and assessors.

	Shotokan term	Other style equivalent or alternative
a) KIHON Three punch combination Rising block, reverse punch, downward block Outside block, reverse punch Outside block, elbow strike, backfist strike Inside block, double punch Knife hand block, front kick, spear hand thrust Double front kick (changing legs) Double side kick (same leg) Roundhouse kick	Sanbon tsuki Age uke, gyaku tsuki Soto uke, gyaku tsuki Soto uke, empi uchi Uchi uke, gyaku tsuki Shuto uke, nukite Mae ren geri Yoko ren gen Mawashi geri	_____ _____ _____ _____ _____ _____ _____ _____ _____
b) KATA 2nd Basic Kata 3rd Basic Kata	Heian Shodan Heian Nidan	_____ _____
c) KUMITE One Step Basic sparring - Attacker using stepping punch to the face and chest	Kihon Ippon Kumite - Jodan and Chudan Oi-tsuki,	_____ _____

Candidates will also be expected to demonstrate in writing, knowledge of:

- the definition of Karate;
- the History of Karate;
- the rules of dojo etiquette;
- the dojo code;
- general code of conduct for Karateka;
- rules of Kata competition;
- the rules and procedures for basic sparring.

Assessment

In addition to the generic banded criteria centres may find the following activity specific assessment criteria helpful.

AS Level PE - Karate - Practical Assessment Criteria

Level	0-6	7-12	13-18	19-24	25-30
KIHON	All techniques or combinations performed with reasonable form and co-ordination.	All techniques or combinations at medium speed with reasonable form and co-ordination.	All techniques or combinations at full speed with good form and co-ordination.	All techniques or combinations at full speed with very good form, good focus, power and smoothness of application.	All techniques or combinations at full speed with very good form, very good focus, maximum power, smoothness of application and vigorous attitude.
All techniques and combinations must be performed a minimum of three times, with Kiai on the last technique or combination.					
KATA			2nd Basic Kata at full speed with good form, and co-ordination.	2nd Basic Kata at full speed with very good form, good focus, power and smoothness of application.	2nd Basic Kata at full speed with very good form, very good focus, maximum power, smoothness of application and vigorous attitude.
	3rd Basic Kate performed with reasonable form and co-ordination.	3rd Basic Kate at medium speed with reasonable form and co-ordination.	3rd Basic Kata at full speed with good form and co-ordination.	3rd Basic Kata at full speed with very good form, good focus, power and smoothness of application.	3rd Basic Kata at full speed with very good form, very good focus, maximum power, smoothness of application and vigorous attitude.
KUMITE	Kihon Ippon Kumite performed with reasonable form and co-ordination and Kiai.	Kihon Ippon Kumite at medium speed with reasonable form and co-ordination and Kiai.	Kihon Ippon Kumite full speed with good form and co-ordination and Kiai.	Kihon Ippon Kumite at full speed with very good form, good focus, power, smoothness of application, good timing and vigorous Kiai.	Kihon Ippon Kumite at full speed with very good form, very good focus, maximum power, smoothness of application, very good timing, correct distance and vigorous Kiai.
At all levels of Kumite, the emphasis must be on good control and safe delivery of attacks and counter-attacks. Kiai should be delivered on every counter-attack, or, where a combination counter is used, on the last technique.					

Tae Kwon Do

The candidate is assessed performing the acquired and developed skills of Tae Kwon Do.

The focus of the tasks will include:

- Line work - a range of basic techniques including basic combinations;
- Patterns – formal exercise sequences;
- Sparring – set sparring and free sparring;

The level of the acquired and developed skill will be measured through the movement phases identified below:

- Line work – Speed, focus, power, accuracy of application, attitude;
- Patterns - Speed, focus, power, accuracy of application, attitude;
- Sparring - Speed, focus, power, accuracy of application, timing, distance, safe control of techniques.

Candidates will be expected to demonstrate their knowledge and understanding of:

- The rules of training hall etiquette;
- The general code of conduct for Tae Kwon-Do students;
- The procedures for patterns of performance;
- The rules and safety procedures for basic sparring.

These phases will be used in conjunction with the generic assessment criteria for Combat activities.

The following are suggestions/exemplars of conditioned competitive situations and are not seen as being prescriptive. Centres may devise their own conditioned competitive situations.

10th KUP	Date			Place		
	Stances	Focus	Power	Tech	Effort	Result
SS FP						
FRK						
10 PU						Comments
WS MP						Examiner
WS LB RP						
WS MB RP						
4DP						
THEORY						

Key to abbreviations

10 th Kup	First Tae Kwon-Do Level
SS FP	sitting stance front punch
FRK	front rising kick
10 PU	10 press ups
WS MP	walking stance middle punch
WS LB RP	walking stance low block reverse punch
WS MB RP	walking stance middle block reverse punch
4DP	4 directional punch exercise 1 & 2
THEORY	Testing on terminology taken from student's handbook up to grade to include Korean and English terms

Candidates will also be expected to demonstrate in writing, knowledge of:

- the definition of Tae Kwon-Do
- the History of Tae Kwon-Do
- the five tenets of Tae Kwon-Do
- general code of conduct in the dojang
- the rules and safety procedures for basic sparring.

Wrestling

The candidate is assessed performing the acquired and developed skills of Wrestling.

The focus of the tasks will include:

- Groundwork
- Attacking

The level of the acquired and developed skill will be measured through the movement phases identified below:

Groundwork:

- Controlling an opponent;
- Execution – (attack moves on the ground – gut wrench, waist roll, leg ride, west point from behind);
- Completion/effectiveness;
- Overall efficiency.

Attacking:

- Entry (penetration step);
- Grip;
- set up, offset balance (attack moves standing- double leg, single leg, high crutch, duck under, arm drag);
- timing;
- throw (fireman's carry, flying mare), completion;
- effectiveness;
- overall efficiency.

These phases will be used in conjunction with the generic assessment criteria for Combat activities.

3.3 Dance activities

1. Artistic Roller Skating (RS)
2. Ballet (Bal)
3. Ballroom Dancing (Latin) (BD)
4. Contemporary Dance (CD)
5. Folk Dance (FD)
6. Ice Dance (ID)
7. Irish Dancing (IrD)
8. Tap dancing (TaD)

Dance – Generic criteria

Performance

The candidate is assessed in:

The performance of a range of basic and advanced skills;

The selection and application of skills and choreographical and compositional ideas;

Physical and mental fitness;

The understanding of the genre of dance, its technical requirements and conventions.

The assessment should take place in conditioned performance situations where tasks of appropriate pitch and challenge that enable candidates to:

Demonstrate a range of basic and advanced skills;

Demonstrate appropriate choreographical and compositional awareness;

Demonstrate an understanding of the genre of dance, its technical requirements and conventions;

Be placed in a rank order in terms of ability.

The focus of these tasks will be on:

- Three solo dances, each lasting approximately 1 minute, with the use of music as a stimulus;
- The dance must include the appropriate technical elements;
- Candidates will produce a written programme prior to assessment and moderation which, depending on the style of dance will include a description of steps, counts beats, explanation of the stimulus selected, the development of motifs, repetition and the phrasing of the dance.

The level of success of the basic and advanced skills will be based on:

- Shape – style and aesthetic quality, consistency and maintaining ambience;
- Form – quality of the individual elements, accuracy and conformity to regulations;
- Consistency – continuity/ flow of the sequence, aesthetic quality, quality of the individual elements and the sequence in relation to amplitude, timing and spatial awareness;
- Control – success in the individual elements and the sequence as a whole.

The level of success in the choreography and the composition will be:

- Elements of composition- improvisation, selection and rejection of movement content, coherency, structure of the dance, relationship and clarity of constituent parts;
- Use of stimuli, appropriateness and use of music/sound/silence in relation to choreography;
- Dynamics;
- Rhythm, timing;
- Use of spatial patterns, shape, line;
- Aesthetic quality, flair, style;
- Originality/appropriate adaptation of movement material.

These assessment phases are used in conjunction with the following assessment criteria for the tasks of appropriate pitch and challenge in authentic contexts.

Band 1 (25-30)

The candidate demonstrates a very high level of acquired and developed skills that show a consistently high standard of accuracy, control and fluency under the pressure of performance.

There is consistent successful selection and application of a wide range of advanced techniques which, under the pressure of performance maintain their accuracy, fluency and control.

A wide range of appropriate choreographical and compositional ideas are successfully used by the candidate demonstrating an excellent understanding of the perceptual and technical requirements of the genre.

The overall standard in the performance situation is excellent and indicative of high levels of learning and understanding.

The candidate demonstrates excellent physical and mental fitness.

The candidate demonstrates an excellent understanding and application of the rules/regulations of the genre.

Band 2 (19-24)

The candidate demonstrates a high level of acquired and developed skills that show a consistently high standard of accuracy, control and fluency under the pressure of performance.

There is consistent successful selection and application of a range of advanced techniques which, under the pressure of performance maintain their accuracy, fluency and control.

A range of appropriate choreographical and compositional ideas are successfully and consistently used by the candidate demonstrating a good understanding of the perceptual and technical requirements of the genre.

The overall standard in the performance situation is very good and indicative of good levels of learning and understanding.

The candidate demonstrates good physical and mental fitness.

The candidate demonstrates a good understanding and application of the rules/regulations of the genre.

Band 3 (13-18)

The candidate demonstrates a sound level of acquired and developed skills that show a consistently good standard of accuracy, control and fluency under the pressure of performance.

There is successful selection and application of a range of advanced techniques which, under the pressure of performance maintain their accuracy, fluency and control.

A range of appropriate choreographical and compositional ideas are successfully used by the candidate demonstrating a sound understanding of the perceptual and technical requirements of the genre.

The overall standard in the performance situation is good and indicative of good levels of learning and understanding.

The candidate demonstrates sound physical and mental fitness.

The candidate demonstrates a sound understanding and application of the rules/regulations of the genre.

Band 4 (7-12)

The candidate demonstrates a limited level of acquired and developed skills that show some accuracy, control and fluency under the pressure of performance.

There is successful selection and application of advanced techniques which, under the pressure of performance usually maintain some accuracy, fluency and control.

Some appropriate choreographical and compositional ideas are successfully used by the candidate demonstrating a limited understanding of the perceptual and technical requirements of the genre.

The overall standard in the performance situation is limited and indicative of limited learning and understanding.

The candidate demonstrates limited physical and mental fitness.

The candidate demonstrates limited understanding and application of the rules/regulations of the genre.

Band 5 (0-6)

The candidate demonstrates a poor level of acquired and developed skills that show little accuracy, control and fluency under the pressure of performance.

There is an attempt to select and apply advanced techniques which, under the pressure of performance maintain little accuracy, fluency and control.

Choreographical and compositional ideas are rarely used by the candidate demonstrating a poor understanding of the perceptual and technical requirements of the genre.

The overall standard in the performance situation is poor and indicative of limited learning and understanding.

The candidate demonstrates inadequate levels of physical and mental fitness.

The candidate demonstrates little understanding and application of the rules/regulations of the genre.

1. Artistic Roller Skating

The candidate is assessed performing the acquired and developed skills of Artistic Roller Skating.

The focus of these skills will include the following:

Basic

- Step from forwards to backward
- Step from backward to forwards
- Outside and inside three turns
- Mohawks
- One foot spin
- Three jump
- Toe loop

Advanced

- Salchow
- Spin F/O
- Loop jump
- Sit spin
- Flip
- Spin B/O
- Step sequence
- Spin combination
- Jump combination
- Axel

The level of success of the acquired and developed skill is measured through the movement phases identified in the generic assessment criteria for Dance.

2. Ballet Dancing

The candidate is assessed performing the acquired and developed skills of Ballet Dancing.

The focus of these skills will include:

- Pirouettes
- Leaps
- Balances

The level of success of the acquired and developed skill is measured through the movement phases identified in the generic assessment criteria for Dance.

3. Ballroom Dancing

The candidate is assessed performing the acquired and developed skills of Ballroom Dancing.

The focus of these skills will include:

- Turns/spins
- Chasse
- Walks

The level of success of the acquired and developed skill is measured through the movement phases identified in the generic assessment criteria for Dance.

4. Contemporary Dance

The candidate is assessed performing the acquired and developed skills of Contemporary Dance.

The focus of these skills will include:

- Leaps
- Balances
- Step patterns
- Turns and travelling

The level of success of the acquired and developed skill is measured through the movement phases identified in the generic assessment criteria for Dance.

5. Folk Dancing

The candidate is assessed performing the acquired and developed skills of Folk Dancing.

The focus of these skills will include:

- Stepping
- Movement
- Rhythm

The level of success of the acquired and developed skill is measured through the movement phases identified below:

- Balanced footwork – equal aptitude of right and left feet, Use of a variety of moods – light and heavy stepping, adaptability of different rhythms, intricacy of stepping;
- Patterns – use of traditional patterns, variety of patterns;
- Communication – awareness of response to audience, awareness of accompaniment.

These assessment phases are used in conjunction with the generic assessment criteria for Dance activities.

6. Ice Dancing

The candidate is assessed performing the acquired and developed skills of Ice Dancing.

The focus of these skills will include:

- Axes
- Patterns
- Steps
- Positions

The level of success of the acquired and developed skill is measured through the movement phases identified in the generic Dance criteria.

7. Irish Dance

The candidate is assessed performing the acquired and developed skills of Irish Dance.

The focus of these tasks will include:

- Leaps/jumps e.g. Irish dance jump, straight jump, hop back jump, cut and double cut jumps, long clicks, back clicks, 'didi-dums';
- Balances e.g. up onto toes, variety of 'rocks';
- Step patterns e.g. 'threes', 'sevens,' 'trebles,' 'twists';
- Turns and travelling.

The level of success of the acquired and developed skill is measured through the movement phases identified in the generic Dance criteria.

8. Tap Dancing

The candidate is assessed performing the acquired and developed skills of Tap Dancing.

The focus of these skills will include the use of:

- Steps with one sound building to complex compound steps;
- A variety of wings;
- Use of a variety of pick ups including one foot, pick up changes and ripple pick ups;
- Travelling steps – forward, backward, sideways and turning;
- A variety of rhythms: 1, +1, +a1, ++a1;
- Head, body and arm lines to portray the style of the dance.

The level of success of the acquired and developed skill is measured through the movement phases identified below:

- Balanced footwork – equal aptitude of left and right feet, use of change of weight – light and shade, clarity of beat, intricacy of stepping, dance in time with the music- optional use of tacit, stop time, change of speed of footwork- fast, medium and slow;
- Patterns – use of floor space, use of stage directions, use of arm lines;
- Aesthetic quality – quality of all movements, use of arm and head lines;
- Communication – interpretation of the music, use of showmanship.

These assessment phases are used in conjunction with the generic assessment criteria for Dance activities.

3.4 Invasion Games

1. Association Football (Af)
2. Basketball (BAS)
3. Field Hockey (Ho)
4. Gaelic Football (GF)
5. Handball (Hb)
6. Hurling (Hu)
7. Ice Hockey (IH)
8. In Line Skater Hockey (ISH)
9. Korfball (Kor)
10. Lacrosse(Lac)
11. Netball (Ne)
12. Polo (Pol)
13. Rugby League (RL)
14. Rugby Union (RU)
15. Roller Hockey (RH)
16. Water Polo (WP)

Invasion Games – Generic criteria

Performance

The candidate is assessed in:

The performance of a range of basic and advanced skills;

The selection and application of skills and tactics;

Physical and mental fitness;

The understanding and application of rules.

The assessment should take place in conditioned competitive situations where tasks of appropriate pitch and challenge enable candidates to:

Demonstrate a range of basic and advanced skills;

Demonstrate appropriate tactical awareness;

Demonstrate an understanding and application of rules;

Be placed in rank order in terms of ability.

The level of success of their basic and advanced skills will be based on the following movement phases;

- Preparation
- Execution
- Recovery
- Result
- Overall efficiency

The level of success in appropriate tactical awareness will be based on:

- Beating opponents
- Support/positioning
- Ball/puck distribution
- Set pieces.

These assessment phases are used in conjunction with the following assessment criteria for the tasks of appropriate pitch and challenge in authentic contexts.

Band 1 (25-30)

The candidate demonstrates a very high level of acquired and developed skills that show a consistently high standard of accuracy, control and fluency under competitive pressure.

There is consistent successful selection and application of a wide range of advanced techniques which, under competitive pressure maintain their accuracy, fluency and control.

A wide range of appropriate strategies and tactics are successfully and consistently used by the candidate demonstrating an excellent understanding of the perceptual requirements of the activity.

The overall performance in the competitive situation is excellent and indicative of high levels of learning and understanding.

The candidate demonstrates excellent physical and mental fitness.

The candidate demonstrates an excellent understanding and application of the rules/regulations of the activity.

Band 2 (19-24)

The candidate demonstrates a high level of acquired and developed skills that show a consistently high standard of accuracy, control and fluency under competitive pressure.

There is consistent successful selection and application of a range of advanced techniques which, under competitive pressure maintain their accuracy, fluency and control.

A range of appropriate strategies and tactics are successfully and consistently used by the candidate demonstrating a good understanding of the perceptual requirements of the activity.

The overall performance in the competitive situation is very good and indicative of good levels of learning and understanding.

The candidate demonstrates good physical and mental fitness.

The candidate demonstrates a good understanding and application of the rules/regulations of the activity.

Band 3 (13-18)

The candidate demonstrates a sound level of acquired and developed skills that show a consistently good standard of accuracy, control and fluency under competitive pressure.

There is successful selection and application of a range of advanced techniques which, under competitive pressure maintain their accuracy, fluency and control.

A limited range of appropriate strategies and tactics are successfully used by the candidate demonstrating a sound understanding of the perceptual requirements of the activity.

The overall performance in the competitive situation is good and indicative of sound levels of learning and understanding.

The candidate demonstrates sound physical and mental fitness.

The candidate demonstrates a sound understanding and application of the rules/regulations of the activity.

Band 4 (7-12)

The candidate demonstrates a limited level of acquired and developed skills that show some accuracy, control and fluency under competitive pressure.

There is successful selection and application of advanced techniques which, under competitive pressure usually maintain some accuracy, fluency and control.

Some appropriate strategies and tactics are successfully used by the candidate demonstrating a limited understanding of the perceptual requirements of the activity.

The overall performance in the competitive situation is limited, inconsistent and indicative of limited learning and understanding.

The candidate demonstrates limited physical and mental fitness.

The candidate demonstrates limited understanding and application of the rules/regulations of the activity.

Band 5 (0-6)

The candidate demonstrates a poor level of acquired and developed skills that show little accuracy, control and fluency under competitive pressure.

There is an attempt to select and apply advanced techniques which, under competitive pressure maintain little accuracy, fluency and control.

Appropriate strategies and tactics are rarely used by the candidate demonstrating a poor understanding of the perceptual requirements of the activity.

The overall performance in the competitive situation is poor, inconsistent and indicative of limited learning and understanding.

The candidate demonstrates inadequate levels of physical and mental fitness.

The candidate demonstrates little understanding and application of the rules/regulations of the activity.

1. Association football

The candidate is assessed performing the acquired and developed skills of Association Football.

The focus of the tasks will include:

- Passing/ distribution
- Receiving/control
- Shooting

- Heading – attacking and defending
- Tackling
- Intercepting
- Closing down
- Jockeying
- Beating an opponent

Goalkeeping

The focus of the tasks will include:

- Shot stopping
- Receiving/distribution
- Taking high balls/crosses
- Punching/palming
- Narrowing angle
- Kicking dead ball/ out of hands
- Clearing back passes

The level of success of the acquired and developed skill is measured through the movement phases identified in the generic Invasion game criteria.

The following are given as suggestions/exemplars of conditioned competitive situations and are not seen as being prescriptive. Centres may devise their own conditioned competitive situations.

It is likely that these situations will be small sided in relation to ‘the normal’ team size.

Association Football 6 v 5

- 1 player is restricted to an area on the half-way line (could be centre circle in football). This player cannot be tackled or closed down.
- Play is restricted to half pitch.
- Goalkeeper is not included in the team numbers but is on the defending side.
- Attacking team can only score from within penalty area.
- Defending team score by passing ball to player in centre circle.

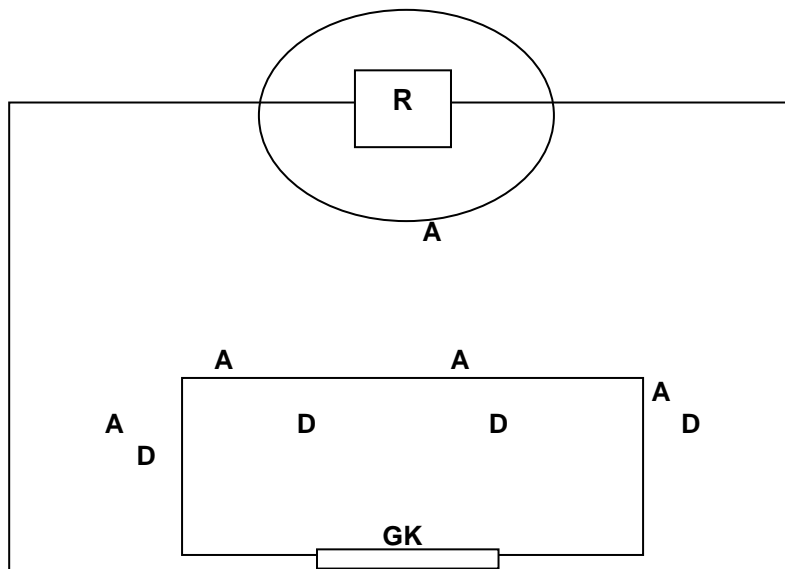

R = Restricted player

D = Defence

A = Attack

GK = Goal Keeper

Candidates are assessed in the selection and application of the acquired and developed skills within:

- passing and receiving
- attacking and defending.

This assessment takes into account the candidates':

- level of accuracy, control and fluency;
- correct selection of technique from the range available;
- consistent success under pressure;
- understanding principles and tactical awareness.

The 'conditions' within the game outlined above can be manipulated or changed to place a different emphasis. However, the conditioned game should always involve the assessment areas identified above. Conditions that could be applied are:

- no tackling.
- the type of pass to be used.
- the number of passes prior to scoring.

2. Basketball

The candidate is assessed performing the acquired and developed skills of Basketball.

The focus of the tasks will include:

- Passing and receiving
- Dribbling
- Shooting
- Marking
- Intercepting

The level of success of the acquired and developed skill is measured through the movement phases identified in the generic Invasion game criteria.

The following are given as suggestions/exemplars of conditioned competitive situations and are not seen as being prescriptive. Centres may devise their own conditioned competitive situations.

Attack 3 v 3

Defence 3 v 3

These two situations can be assessed using the same half-court game.

The team on the attack commences from the mid-court line. The defending team attempt to prevent a score. The attack is completed on a score or loss of possession. Fouls on a shooter gives this player one free shot. Other fouls by defenders result in the attack starting again.

Attacking team have five attempts then change to defend.

Team membership should be varied over a series of games.

Half court conditioned game

- (i) Player to player defence
- (ii) No pressing defence
- (iii) No zone defence

This assesses ability in a team competitive situation. Wherever possible the candidate should experience playing in each of the three attacking situations: guard, forward and centre in order that their and application of the skills and tactics appropriate to each position can be demonstrated.

3. Field Hockey

The candidate is assessed performing the acquired and developed skills of Field Hockey.

The focus of the tasks will include:

- Passing/ distribution
- Receiving/control
- Dribbling
- Shooting
- Tackling
- Intercepting
- Closing down/jockeying
- Beating an opponent

Goalkeeping

The focus of the tasks will include:

- Shot stopping
- Receiving/distribution
- Narrowing angle
- Defending short corners
- Saving penalty flicks

The level of success of the acquired and developed skill is measured through the movement phases identified in the generic Invasion game criteria.

The following are given as suggestions/exemplars of conditioned competitive situations and are not seen as being prescriptive. Centres may devise their own conditioned competitive situations.

It is likely that these situations will be small sided in relation to 'the normal' team size.

6 v 5

- 1 player is restricted to an area on the half-way line (could be centre circle in football). This player cannot be tackled or closed down.
- Play is restricted to half pitch.
- Goalkeeper is not included in the team numbers but is on the defending side.

- Attacking team can only score from within penalty area.
- Defending team score by passing ball to player in centre circle.

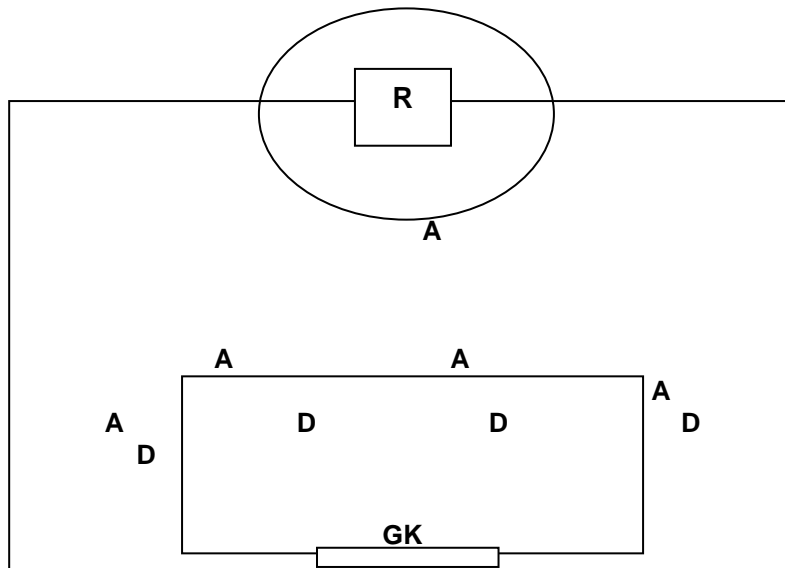

R = Restricted player

D = Defence

A = Attack

GK = Goal Keeper

Candidates are assessed in the selection and application of the acquired and developed skills within:

- passing and receiving
- attacking and defending.

This assessment takes into account the candidates':

- level of accuracy, control and fluency;
- correct selection of technique from the range available;
- consistent success under pressure;
- understanding principles and tactical awareness.

The 'conditions' within the game outlined above can be manipulated or changed to place a different emphasis. However, the conditioned game should always involve the assessment areas identified above. Conditions that could be applied are:

(a) no tackling;

- (b) the type of pass to be used;
- (c) the number of passes prior to scoring.

4. Gaelic Football

The candidate is assessed performing the acquired and developed skills of Gaelic Football.

The focus of the tasks will include:

Handling
Tackling
Intercepting
Running with the ball
Kicking
Shooting

The level of success of the acquired and developed skill is measured through the movement phases identified in the generic Invasion game criteria.

5. Handball

The candidate is assessed performing the acquired and developed skills of Handball.

The focus of the tasks will include:

- Passing/receiving
- Moving with the ball
- Shooting
- Marking/jockeying
- Intercepting
- Supporting

The level of success of the acquired and developed skill is measured through the movement phases identified in the generic Invasion game criteria.

6. Hurling

The candidate is assessed performing the acquired and developed skills of Hurling.

The focus of the tasks will include:

- Grip and swing
- Striking a stationary ball (strong and weak sides)
- Roll lift and catch
- Balancing ball on hurley
- Palming the ball
- Running and striking ball
- Blocking
- Jab-lift
- Catching ball overhead
- Solo run
- Striking from hand
- Free taking
- Raising moving ball into hand
- Doubling forward
- Sideline cut

The level of success of the acquired and developed skill is measured through the movement phases identified in the generic Invasion game criteria.

7. Ice Hockey

The candidate is assessed performing the acquired and developed skills of Ice Hockey.

The focus of the tasks will include:

- Passing and receiving
- Shooting
- Marking
- Delaying/jockeying
- Moving with the puck
- Supporting
- Intercepting

Net Minder

The focus of the tasks will include:

- Shot stopping
- Receiving/distribution
- Use of gloves/blocker
- Narrowing angle
- Rebound control
- Recovery

The level of success of the acquired and developed skill is measured through the movement phases identified in the generic Invasion game criteria.

The following are given as suggestions/exemplars of conditioned competitive situations and are not seen as being prescriptive. Centres may devise their own conditioned competitive situations.

Conditioned Competitive Situation Exemplars

Passing and receiving

- 1 In 2s, static, pass to each other forehand and backhand.
- 2 In 2s

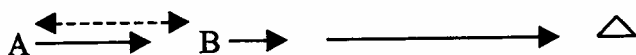

Player A moves forward

Player B moves backwards

Players keep passing to each other until  is reached, then reverse direction

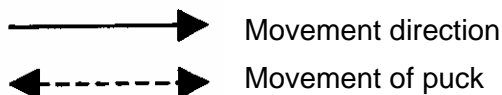

- 3 In 3s - Level passing (working in a square)

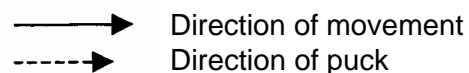
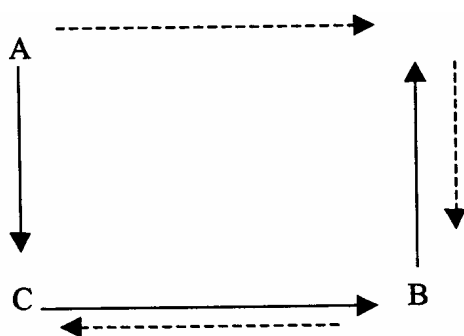

- A can only pass level
- B moves forward to receive pass
- B can only pass level
- C moves forward to receive pass
- C can only pass level
- A moves forward to receive pass

4 Flip pass - forehand and backhand

Static in 2s

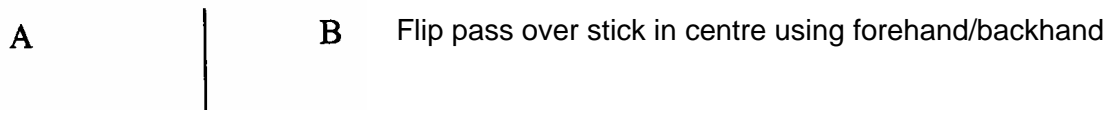

5 Attacking 2v1

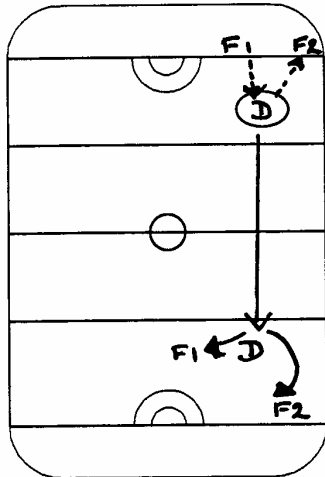

F1/F2 with puck

D Defenseman in face off circle

F1 to D

D to F2

F 1 & F2 work together, passing down rink until in a position when F 1 goes to centre to shoot

Or

F2 goes wide (down boards) player not shooting drives to the net

6 Defending 2v2

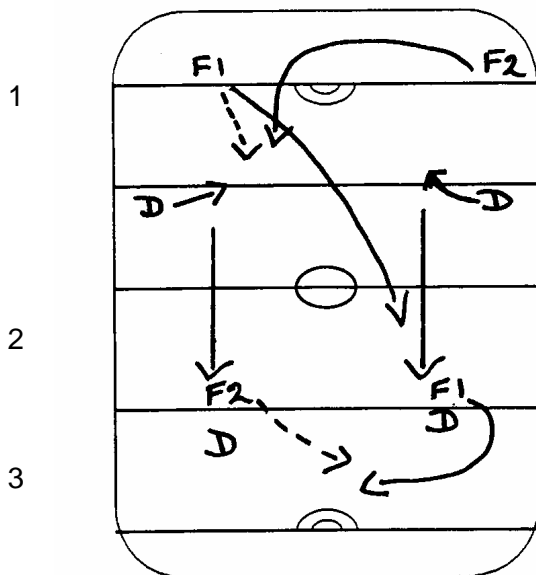

Two forward players F1 & F2 Two Defensemen D

1. F1 with Puck

F2 skates round back of net to receive pass from F1

Defensemen take on one player each and work backwards

2. D try to give F bad shooting angle (i.e. force player wide)

3. F 1 tries to get into good position to receive pass and shoot

Man to Man marking

Middle rink - poke check

Boards - body check

It is likely that these situations will be small sided in relation to the 'normal' team size.

7 6 v 5 Conditioned

Play restricted to half rink

One player restricted to circle on centre line (R)

Goalkeeper not included in team numbers but is on defending side

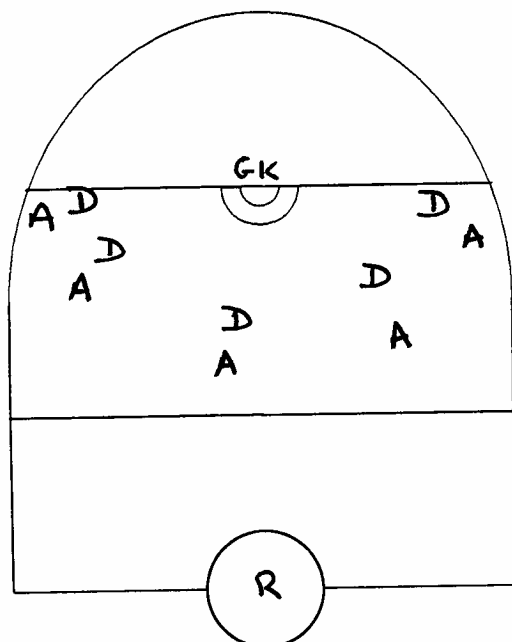

R – Restricted player must stay within circle

D – Defenseman

A – Forward player

Candidates are assessed in the selection and application of the acquired and developed skills within:

- Passing and receiving
- Attacking and defending

This assessment takes into account the candidate's:

- level of accuracy, control and fluency;
- correct selection of technique from the range available;
- consistent success under pressure;
- understanding principles and tactical awareness.

The 'conditions' within the game outlined above can be manipulated or changed to place a different emphasis. However, the conditioned game should always involve the assessment areas identified above. Conditions that could be applied are:

- (a) Defences have to turn sticks upside down;
- (b) The type of shot used;
- (c) The number of passes prior to scoring.

8. In-Line Skater Hockey

The candidate is assessed performing the acquired and developed skills of In-Line Skater Hockey.

The focus of the tasks will include:

- Skating
- Passing and receiving – Forehand/backhand
- Shooting – slap shot/wrist shot
- Stick handling
- Marking
- Moving with the puck
- Beating an opponent
- Supporting
- Intercepting

The level of success of the acquired and developed skill is measured through the movement phases identified in the generic Invasion game criteria.

The following are given as suggestions/exemplars of conditioned competitive situations and are not seen as being prescriptive. Centres may devise their own conditioned competitive situations.

Conditioned Competitive Situations

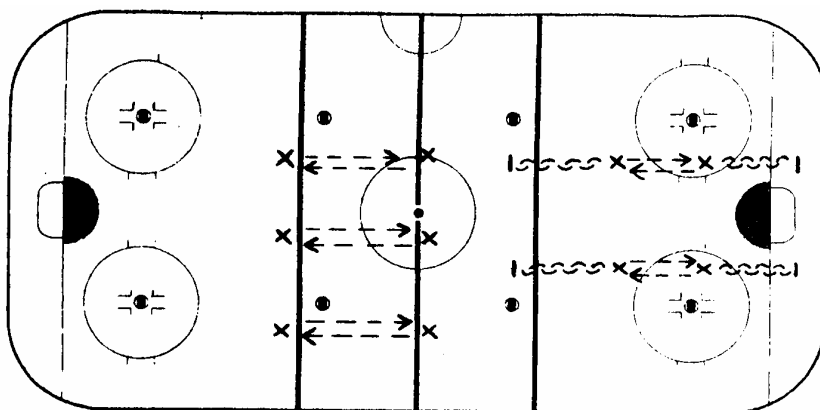

Drill 1: Two players one on the centre line and one on the blue line, pass the puck between them varying from forehand, backhand and saucer pass.

Drill 2: Two players stay approx. 5m apart to do one touch passes on the move. One will skate forward whilst the other is skating

backwards. They then stop and change direction.

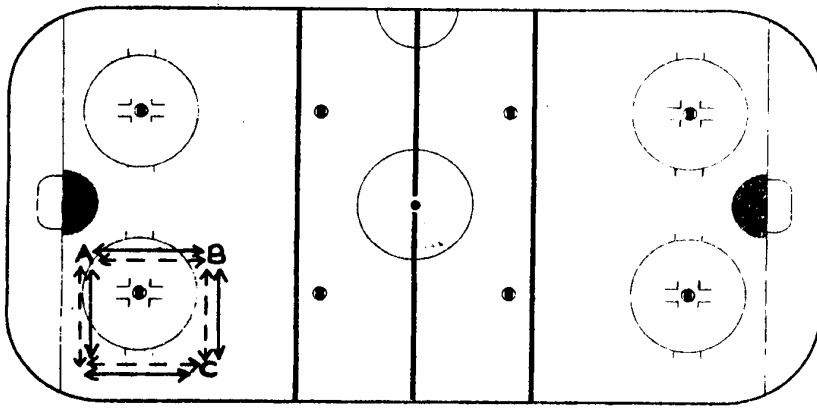

Three players form a square with one corner not taken. They pass along the lines of the square forcing one player to use quick feet and skate into the vacant corner.

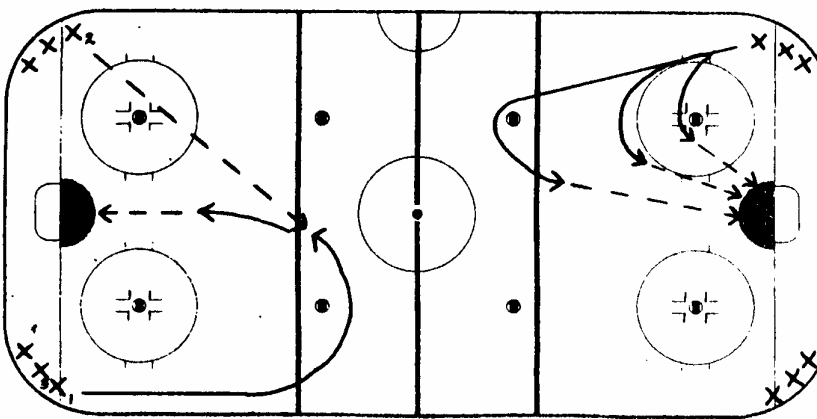

Drill 1: Player (x1) comes out of corner over blue line and curls in receiving a pass from the other corner (x2) and takes a shot. The other corner (x2) then goes when they have made the pass. This player receives the pass from (x3) and so on.

Drill 2: Three players go out of one corner first one goes across the face off dot, second one goes across the top circle and the third one goes over the blue line. They all take a shot in turn. Other corner follow, vary distance and change corner.

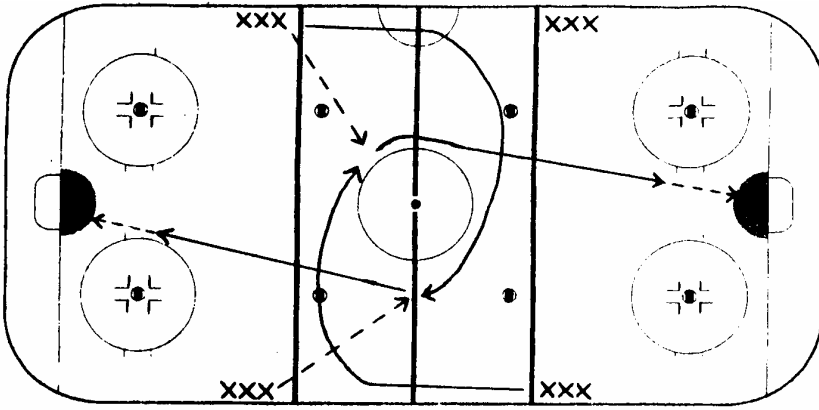

Players on all four corners of the blue line. Opposite corners go together, man skates up the boards round the circle and receives a pass from the opposite corner, then goes in and shoots. Other two corners then go.

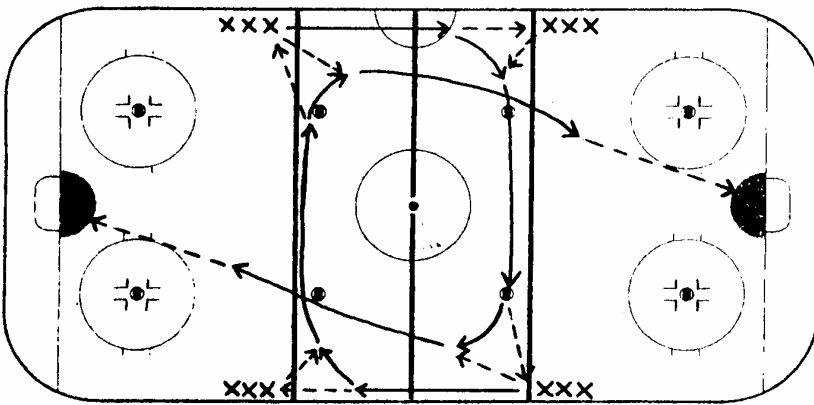

Players on all four corners of the blue line. Opposite corners go together, man skates up the boards with a puck and exchanges passes with the man in queue, then skates across the blue line and exchange passes with man in queue, goes down boards and takes a shot. Other two corners then go.

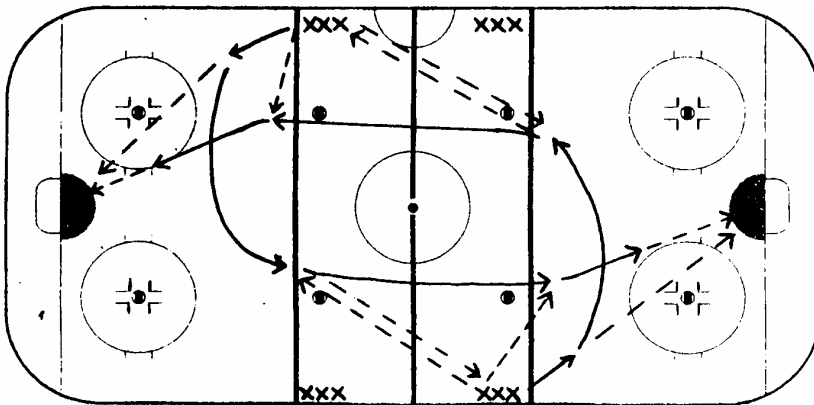

Players on all four corners of the blue line. Opposite corners go together. Man goes just inside blue line and takes a shot he then curls and receives and returns a pass from the opposite corner, and takes a shot. Other corners then go. He skates across other blue line where he receives

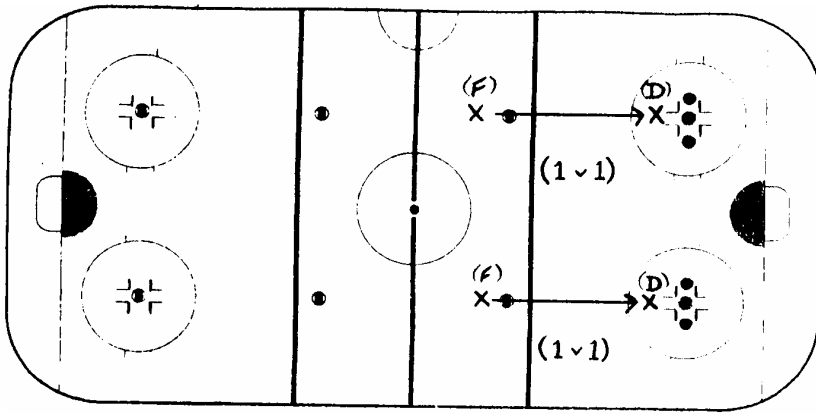

Three pucks are placed on both face off dots in one end. Defencemen protect them without a stick. Forwards skate in and try and get one puck at a time. Only when they have scored can they move onto the next puck. Goaltenders must be aware of both sides.

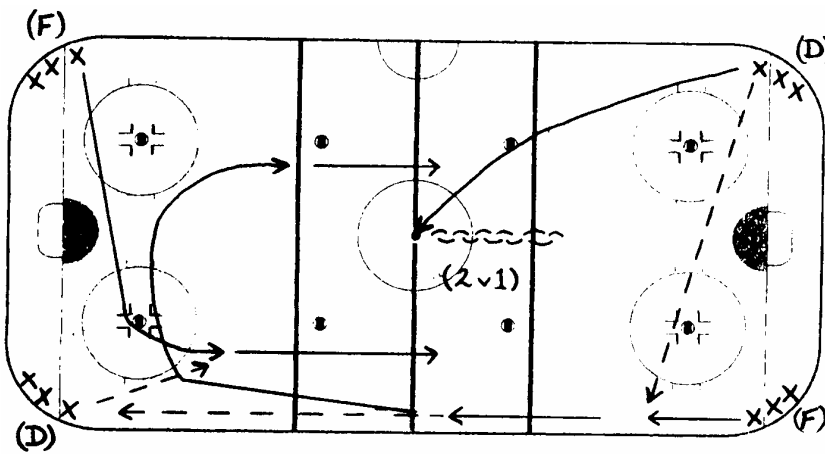

Full ice. Defencemen in opposite corners and forwards in opposite corners. Defenceman passes across to forward in the same end who skates hard down the boards and passes to defenceman, he then curls round to opposite wing. Other forward skates across ice and picks up the pass.

Defencemen who started the drill will have skated to the centre line and pivoted backwards to create a two on one. Other end then start the drill.

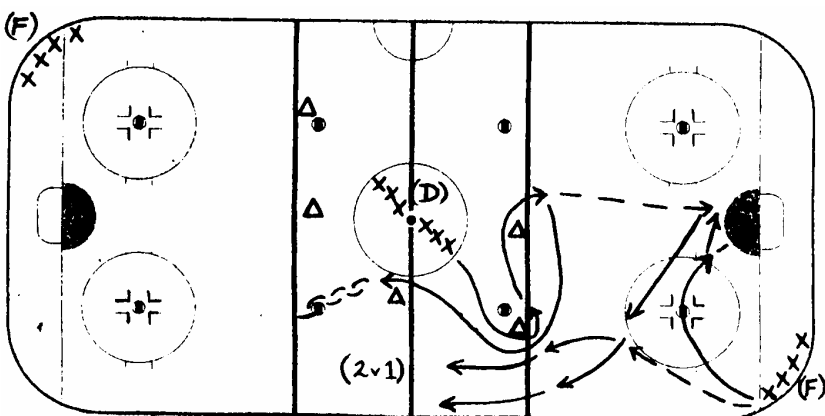

Forward skates over face off dot and takes a shot. Defenceman skates around cones and takes a low shot for the forward to tip in.. Defenceman then skates forward and pivots backwards around cones. Whilst forward receives a pass from his line and skates down the boards. Forward who passed the

puck to the first forward joins the play to create a two on one.

9. Korfball

The candidate is assessed performing the acquired and developed skills of Korfball.

The focus of the tasks will include:

- Passing and receiving
- Footwork
- Shooting
- Marking
- Supporting
- Intercepting/collecting

The level of success of the acquired and developed skill is measured through the movement phases identified in the generic Invasion game criteria.

The following are given as suggestions/exemplars of conditioned competitive situations and are not seen as being prescriptive. Centres may devise their own conditioned competitive situations.

Drill One

In pairs short and long passes within grid using:

- Two handed chest pass
- One handed shoulder pass
- One handed underhand pass
- One handed overhand pass

A starts with ball, **B** moves and receives pass.

A moves and receives pass etc.

Vary passes and obey footwork rules.

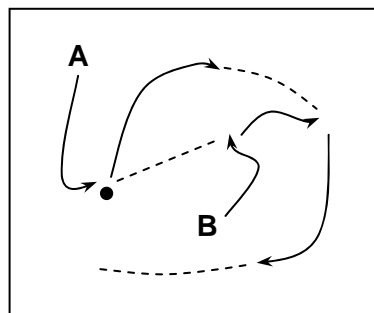

Drill Two

In 5s, variety of passes to control player, move to receive, return pass and pass to head of opposite queue i.e.

A → E → A → C

C → E → C → B

B → E → B → D

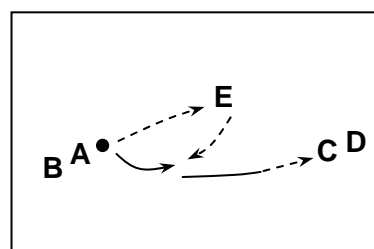

Drill Three

In pairs, drill with tactical aspect.

A & B run forward as a pair.

A to receive pass from feeder (**F**).

B to intercept, **A** returns pass to feeder.

Next pair, **C & D**, repeat.

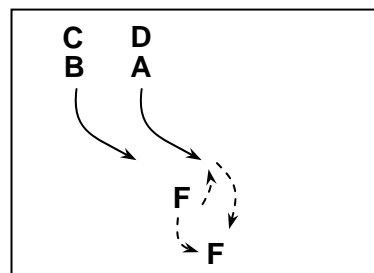

Progression:

If **B** gets into position to intercept,
A makes reverse move to lose **B**.

In all passing/receiving drills use appropriate passes and vary jump/running/stationery reception.

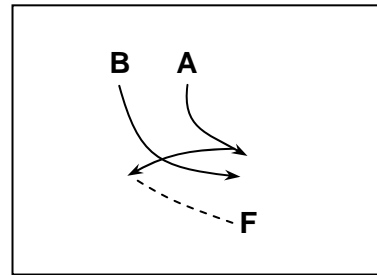

Attack and Defence

Half court 4 v 4 game. Full rules and gender marking to apply.

Defence to concentrate on: Prevention of goals by effective positioning between attacker and goalpost thereby denying a shot.

Interception of the ball in order to take defensive initiative.

Attack to concentrate on: Keep possession by continually passing around until a player is free and a scoring chance is created.

Creation of space by movement patterns using feints, agility, starting, stopping and change of pace.

10. Lacrosse

The candidate is assessed performing the acquired and developed skills of Lacrosse.

The focus of the tasks will include:

- Passing and receiving
- Carrying/cradling
- Shooting
- Marking
- Tackling
- Supporting
- Intercepting

The level of success of the acquired and developed skill is measured through the movement phases identified in the generic Invasion game criteria.

The following are given as suggestions/exemplars of conditioned competitive situations and are not seen as being prescriptive. Centres may devise their own conditioned competitive situations.

CONDITIONED COMPETITIVE SITUATIONS

1. Receiving, carrying and passing from front, side and behind on the move, using dominant and non-dominant hand positions.

Situation:

Players in line. 2 Feeders, side and front. Each player works in turn through 6 pass sequence. Players using dominant hand positions, then non-dominant and finally changing from one to the other throughout.

Diagram 1

P1 starts with ball, sprints towards F2 giving and receiving pass from F1.

Continues towards F2 exchanging long front pass.

Carries ball round F2, flip pass to F2, then runs diagonally away to receive return pass from F2 from behind.

Finally passing to P2 who commences his turn.

Notes

- (i) Quality of footwork, speed, accuracy and timing of passes are crucial.
- (ii) Stress importance of quick recovery from any mishandling.
- (iii) Players become Feeders at intervals and in rotation.

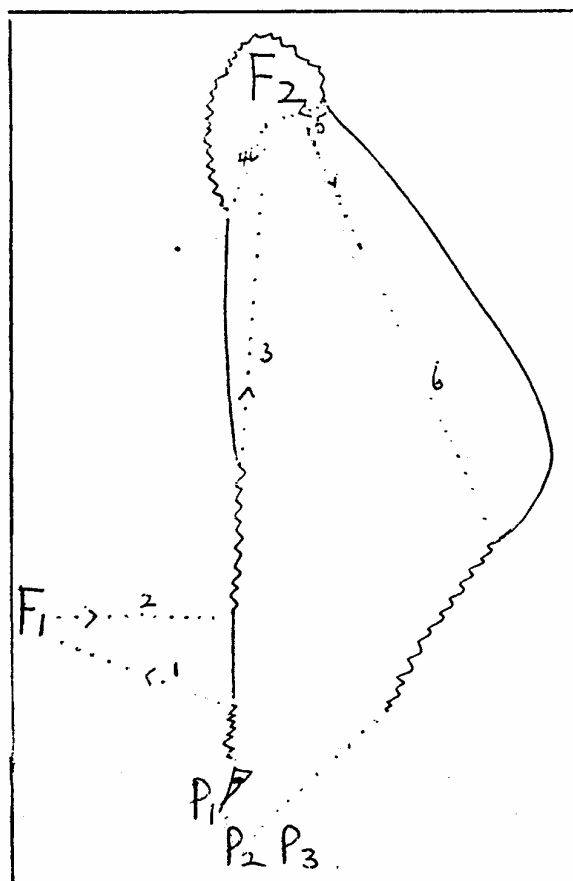

2. Retrieval of loose ground ball – Competitive Conditioned Game 1/3 Field

Situation:

Players in 2 lines on either side of coach, who rolls ball towards goal between players.

On call, players compete for possession. Player winning ball progresses to goal to score, loser tries to prevent or block shot.

Quality to Assess:

Speed of reactions, legal use of feet, body and stick to protect and gain, prevent and protect possession.

Points awarded to each player, team for clean possession.

Diagram 2 _ Ground Ball Competitive Drill

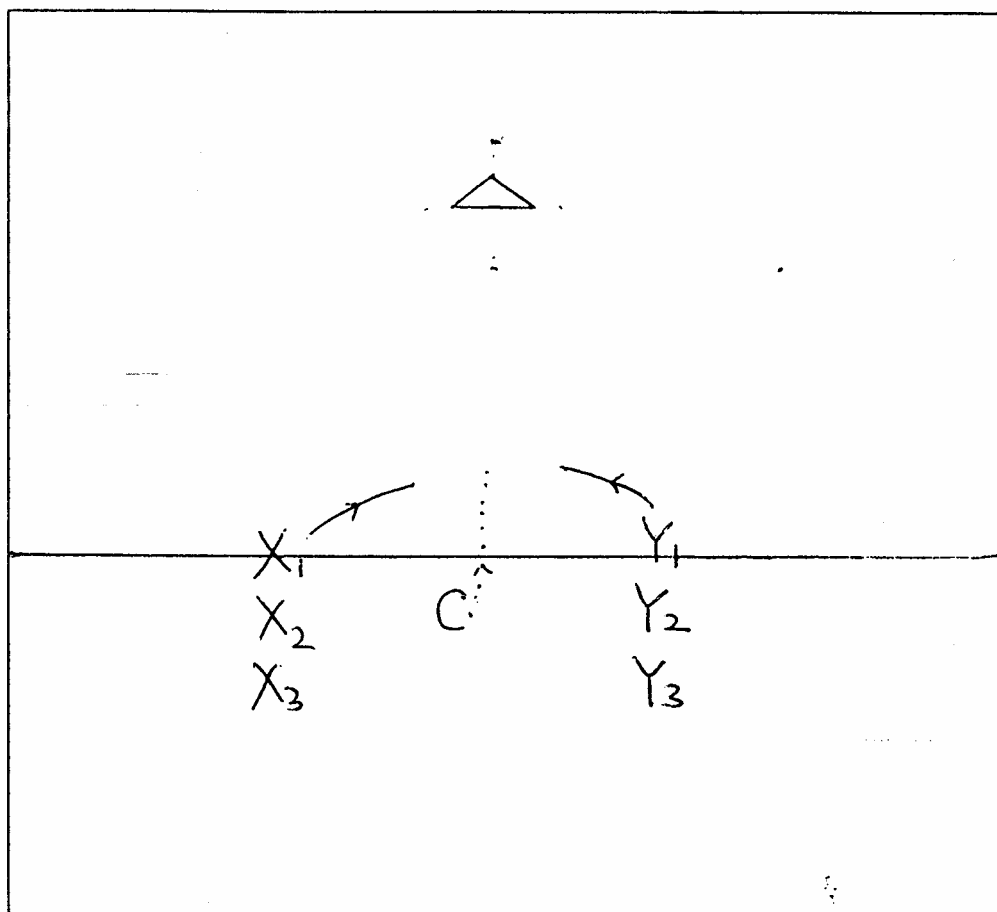

3. Attack and Defence

- (A) 3 on 3. $\frac{1}{4}$ field competitive conditioned game.
Both Attack and Defence can be assessed using same game.

Play commences with Attack in possession. Defenders try to prevent score and clear. Attack completed on score, or loss of possession, or clearance by Defence.

Attacking team has 5 attempts, then change to Defence.

Points awarded to Attack for realistic attempt (1) or Goal (3) and to Defence for effective check, block, interception (1) or clearance (3).

Conditions:

- (i) Each attack player commences play in turn.
- (ii) Scoring attempted only after declared number of passes (3-5), or declared times (20-30-60 seconds).
- (iii) Play starts with face-off – team winning possession becomes Attack.

(B) Extra Man Situations. Fast Break. ½ field competitive Conditioned Game. 3 Attacks – 3 Defenders around Goal area. Midfielders in turn carry ball from halfway line to create extra man attack on goal.

To assess correct movement, positioning, awareness of options for Defenders and Attackers.

Points awarded to Defence for successful prevention of score and to Attack for each goal or opportunity.

After declared number of attempts Ms and As exchange positions and Ds rotate.

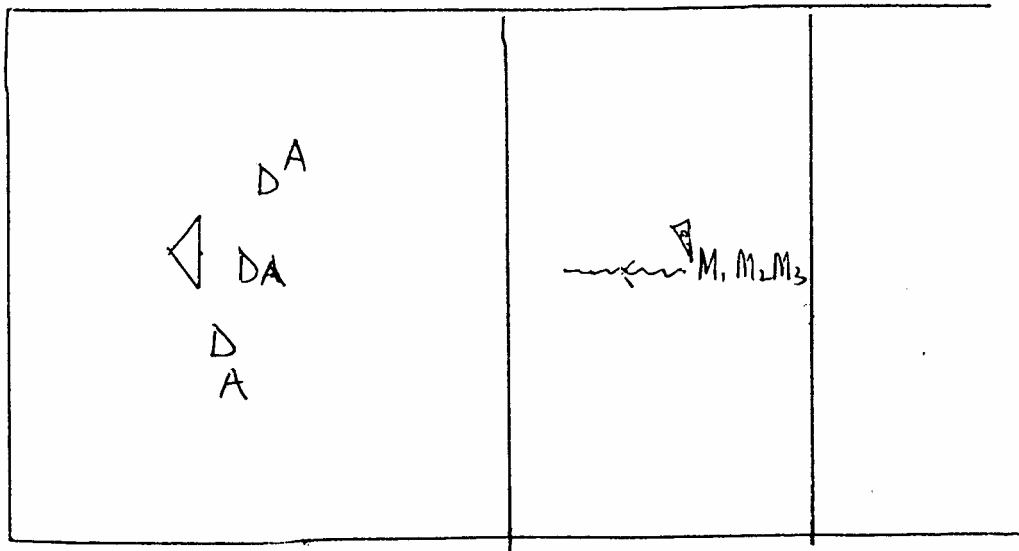

- (C)** 6 on 6
½ field Competitive Conditioned Game
Same game requirements as 3 on 3 above.

This assesses ability in a team competitive situation. Players should demonstrate good handling skills, effective positioning and movement, good communication and awareness to support team and to create/prevent scoring opportunities.

Conditions:

- (i) With regular Man on Man Defence.
- (ii) With Pressing Defence
- (iii) Extra Man 6 on 5. After foul (real or declared by coach).

Play commences with only 5 defenders. Attackers use extra man to create goal or good scoring opportunity. Defenders use zone to counteract attempts.

Coach to vary time penalties and to allow attackers extra attempts before re-admitting player from penalty box.

11. Netball

The candidate is assessed performing the acquired and developed skills of Netball.

The focus of the tasks will include:

- Passing and receiving
- Footwork
- Shooting
- Marking
- Supporting
- Intercepting

The level of success of the acquired and developed skill is measured through the movement phases identified in the generic Invasion game criteria.

The following are given as suggestions/exemplars of conditioned competitive situations and are not seen as being prescriptive. Centres may devise their own conditioned competitive situations.

DRILL 1

A

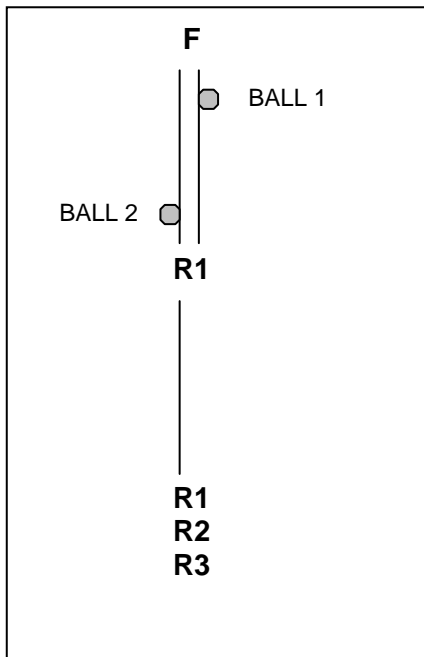

B

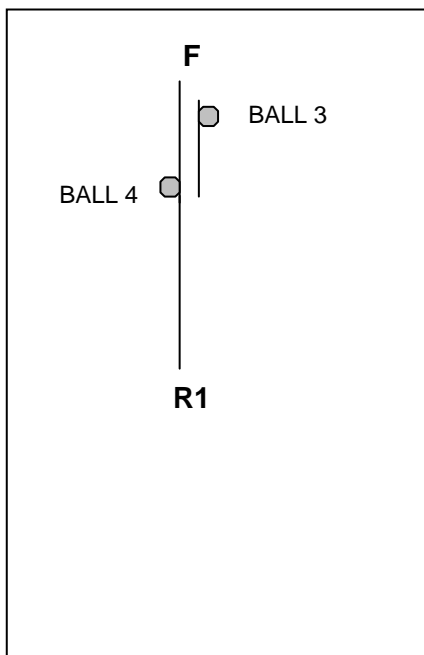

PASSING AND RECEIVING

Conditioned activities to demonstrate the variety and quality of the pass and the opportunity to use different footwork and demonstrate the speed and agility of the performer. Drills to work on and then perform team v team or timed (etc).

A: F pass to just beyond ½ court (ball 1). R1 drives into receive. R1 gives quick ball back to F (ball 2).

B: F now sends a high jump ball (ball3). R1 carries on running forward jumps forward to collect high ball. (can demo volley or right left hand catch). R1 catches and gives quick ball back to feed (can be quick under arm).

C

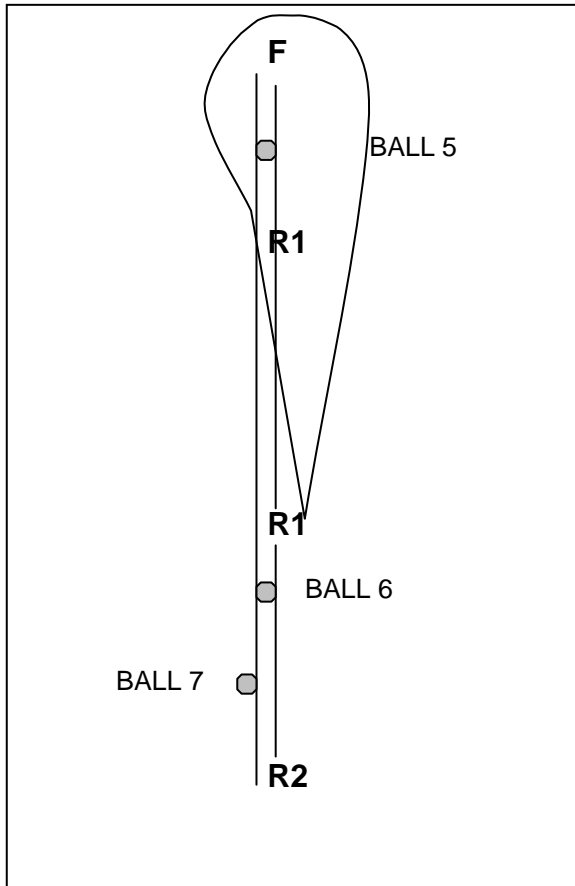

R1 now runs around the back of F looks for the ball and sprints forward to collect a 'loose' roll (a dropped ball) or a bounce pass from F (ball 5). R1 collects and decides on type of pass to give to R2 (can use rugby ball pick up and underarm) (ball 6). R2 send a long ball back to F to start the process again (ball 7).

Notes

- F remains on the spot all passes straight. Can vary with angle on first ball right or left angle on ball 5.
- Add competition team v team or time the squad back to start or number of laps in a given time.
- Number of receives can be 4/5/6.

DRILL 2

2 Teams and 2 balls – explained for 1 team over 2/3 court however both teams must work at the same time.

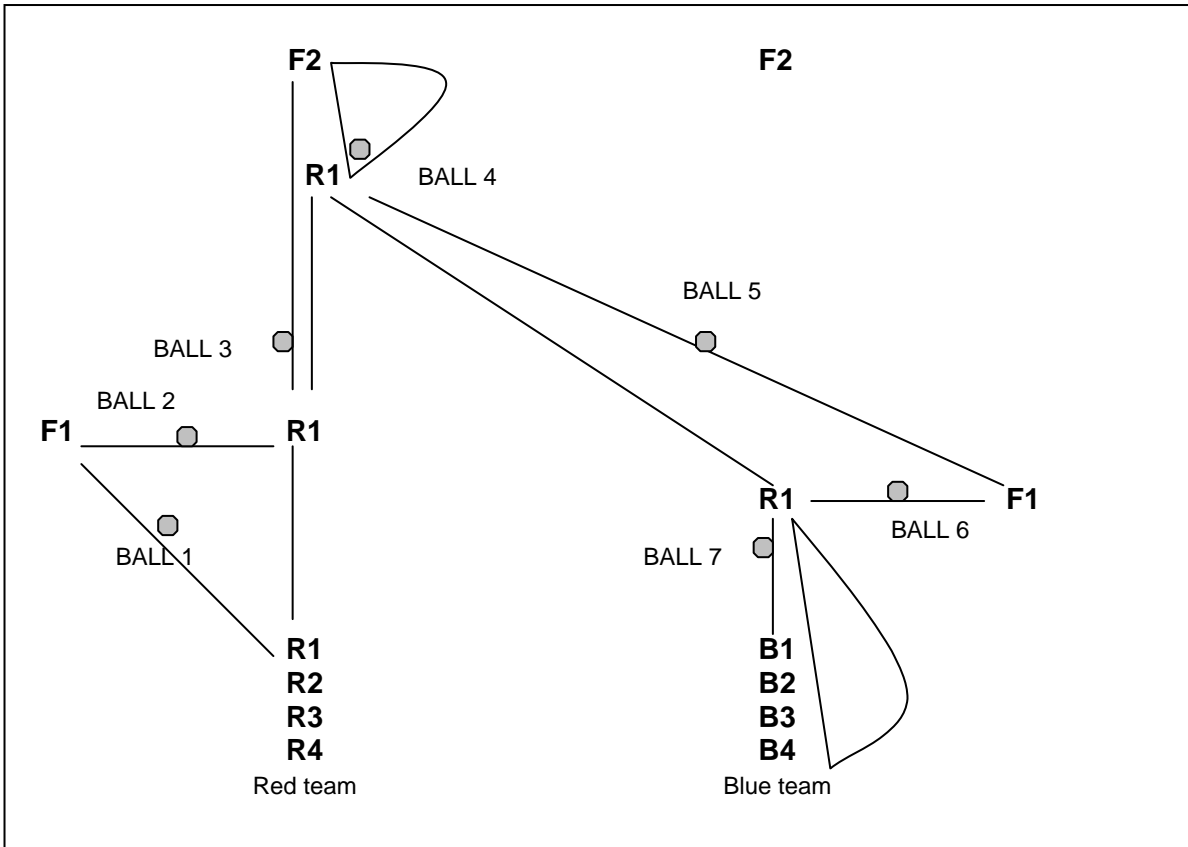

R1 starts with the ball, 2 feeders for each team F1 and F2, R1 gives a quick pass to F1 (ball 1) who is on an angle at the side line. R1 sprints forward and collects a square flat ball from F1 (ball 2). R1 now sends a long straight ball (ball 3) to F2 and R1 sprints forward to approx 1.5 metres away from F2, F2 sends a high jump ball (ball 4) R1 jumps to collect and demos a turn in the air to land and face F1 for opposing team side. R1 sends a diagonal pass to F1 (ball 5). R1 drives on a angle to collect a flat ball from F1 (ball 6). R1 then sends a straight flat ball to blue B1 (ball 7). R1 sprints down line to join opposite queue. Quality of footwork, speed and accuracy of pass are crucial.

Notes

- As R and R2 start they must stay together so it maybe necessary to hold the first pass when it is returned.
- Condition the game by setting team task of “getting there and back” (if a ball is a bad pass players must be quick to retrieve).

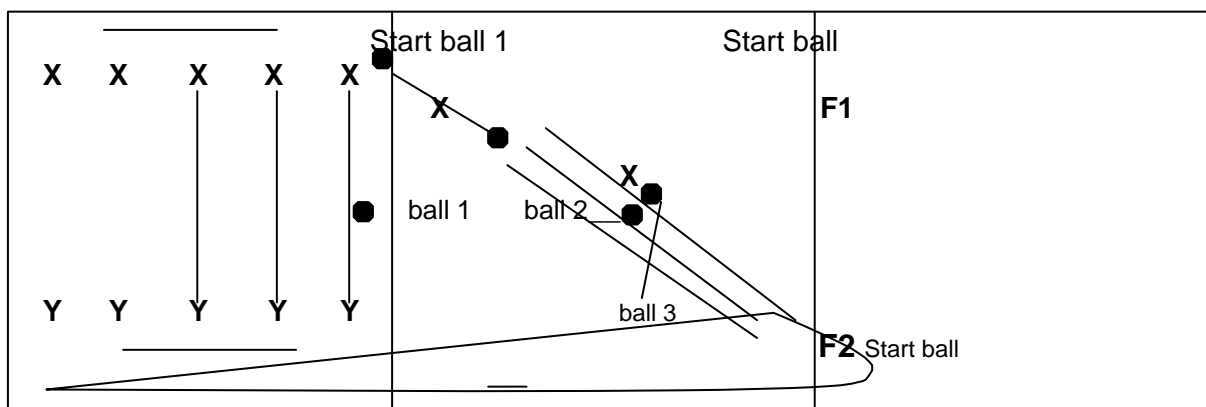
DRILL 3**'3' BALL**

1. Starts as above
 - (a) Ball passes from X to Y.
 - (b) X then drives on an angle towards F2 to receive ball 2 from F2
 - (c) X gives a quick ball back to F2
 - (d) X carries on running round F2 and sprints down the side line to join the queue. (there may be no queues when the practice is done at speed).

2. Y gives the ball back to the next player on the X row and also drives across to collect the flat ball from F1. She does exactly the same as X did.

Notes

- The teams should establish a pattern and the 3 balls keep moving
- Try a high feed from F or a bounce pass.
- Coach shouts 'change' and the X and Y approaching F1 and F2 change over to become feeders.
- Use as a team relay or timed 'there and back'.

Half Court Conditioned Games

4 v 4

C-WA-GA-G
C-WD-GD-GK

(A) Attack

Challenge for the attacking team to get the ball into the circle in:-

- 4 passes
- 3 passes
- 2 passes

If the attackers put the ball out of the court, or if the defence make an interception, take the centre again.

Score out of 10 attempts.

(B) Defence

Same activity – however the attacking team must do 8/10 passes before attackers can shoot.

Defence to try person to person defence

- blocking
- zone defence

(C) Attack

Taking a throw from the goal third sideline, backline and goal line.

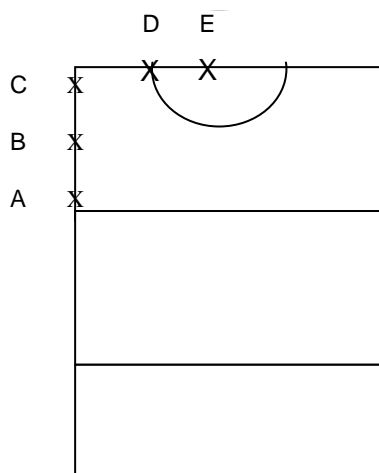

Attackers take the 'throw-in' from each of the 5 positions marked on both left and right side.

Attackers show movements to:

- create space
- hold space

Score

- (a) the number of times out of the 10 starts that the shooter receives the ball in the circle.
- (b) the number of goals scored out of the ten attempts.

(D) Defence

Defence bring the ball out of the goal third and win a point if they keep possession of the ball and pass it to their own centre who was to receive the ball in their attacking third.

Score a point for:

- (a) ten passes;
- (b) ten passes and taking the ball to the sideline.

12. Polo

The candidate is assessed performing the acquired and developed skills of Polo.

The focus of the tasks will include:

- Passing and receiving
- Shooting
- Marking
- Supporting
- Intercepting

The level of success of the acquired and developed skill is measured through the movement phases identified in the generic Invasion game criteria.

The following are given as suggestions/exemplars of conditioned competitive situations and are not seen as being prescriptive. Centres may devise their own conditioned competitive situations.

The conditions within the game can be manipulated or changed to place a different emphasis but should always involve the assessment areas outlined above. Conditions that could be applied are:

1. no ride off
2. specific pass to be used
3. number of hits or taps to be used prior to scoring
4. no hooking

- **1v1**

This conditioned competition situation can be used to assess attacking or defensive play.

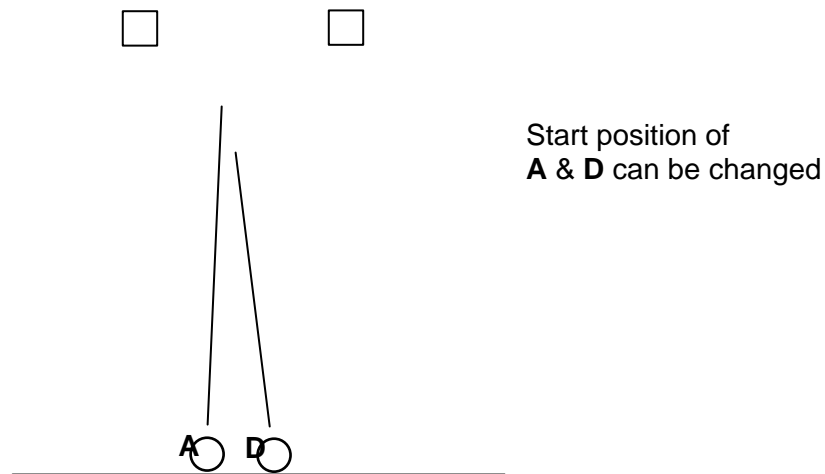

- From 60yd line
- 1 attack, 1 defence
- Attacker to ride in to goal and score
- Defender to try to ride attacker off the line (ball)
- 1 point scored in attack when goal scored
- 1 point in defence when successful in riding off.

- **2v2**

Half pitch game.

In this conditioned competition situation particularly the conditions outlined previously can be applied. (no ride off / limited pass type I minimum number of hits or taps prior to scoring i.e. 5 from centre, 10 from wing)

- Goal scored by attacking team scores them a point
- Defence hitting ball back over $\frac{1}{2}$ way line scores them a point.

13. Rugby League

The candidate is assessed performing the acquired and developed skills of Rugby League.

The focus of the tasks will include:

- Passing and receiving
- Retaining possession
- Off loading/recycling
- Supporting
- Tackling
- Running with ball/beating opponents

The level of success of the acquired and developed skill is measured through the movement phases identified in the generic invasion game criteria.

The following are seen as suggestions/exemplars of conditioned competitive situations and are not seen as being prescriptive. Centres may devise their own conditioned competitive situations.

Defending

1. Player A is the defender whose task it is to tackle the other five members of the group in turn. Player A starts from line A, retreats to line B and at this point the attacker commences their run forward. Player A must advance and make the tackle, driving the attacker backwards and then assume marker position and finish with a chase to the end of the grid before repeating the drill with the next attacker.

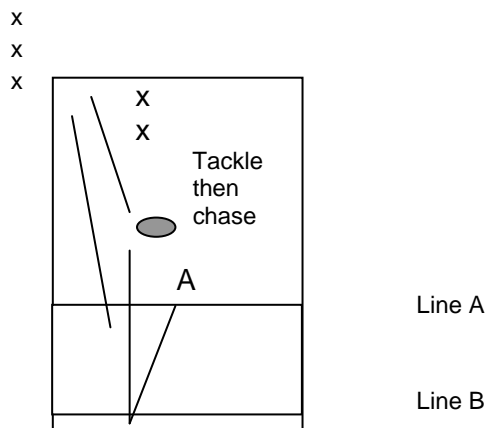

2. Two teams line up in opposition 10m apart with six balls placed in the centre position indicated. Team A attacks and retains possession even if they make a mistake. Team B must therefore continually defend. After a set of six tackles the teams return to the start and repeat. All six balls should be used to overload the defence.

A set of cones should mark the defending team's position and coaches should look for the initial upwards movement before commencing a slide.

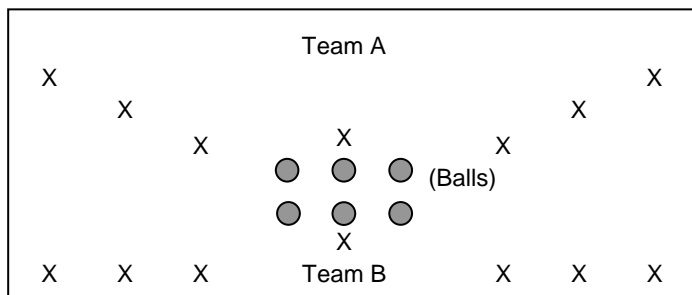

Attacking

1.
3 v 2

Two defenders face three attackers in a 20m grid. The defenders grubber kick the ball towards the attackers who pick it up and commence an attack against the defence, looking for space as they see fit. After a score or an error; attackers become defenders and the drill is a continuous practice.

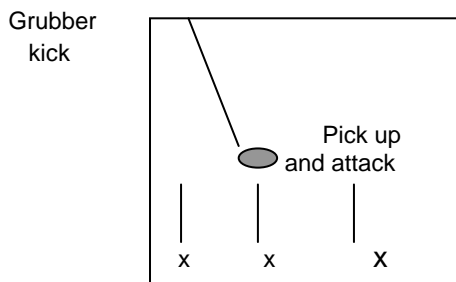

2. Five players line up at the end of a 20m grid. Each player is numbered one to five and the coach calls out any two of those numbers who become the defenders by racing out to the marked cones, as soon as the defenders reach the cones the remaining three players start their attack attempting to score by any means they see fit.

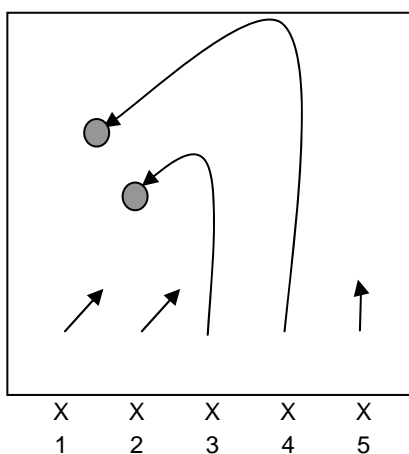

14. Rugby Union

The candidate is assessed performing the acquired and developed skills of Rugby Union.

The focus of the tasks will include:

- Passing and receiving
- Running with the ball
- Ball distribution
- Tackling
- Retaining ball in a maul
- Retaining possession on floor/setting ruck
- Skills appropriate to candidate's position
- Beating an opponent
- Supporting
- Running with ball/beating opponents

The level of success of the acquired and developed skill is measured through the movement phases identified in the generic Invasion game criteria.

15. Roller Hockey

The candidate is assessed performing the acquired and developed skills of Roller Hockey.

The focus of the tasks will include:

- Passing/ distribution
- Receiving/control
- Dribbling
- Shooting
- Tackling
- Intercepting
- Closing down/jockeying
- Beating an opponent

Goalkeeping

The focus of the tasks will include:

- Shot stopping
- Receiving/distribution
- Narrowing angle
- Defending short corners
- Saving penalty flicks

The level of success of the acquired and developed skill is measured through the movement phases identified in the generic Invasion game criteria.

The following are given as suggestions/exemplars of conditioned competitive situations and are not seen as being prescriptive. Centres may devise their own conditioned competitive situations.

- 1 Receiving, carrying and passing from front, side and behind on the move, using both sides of stick.

Situation:

Players in line. 2 feeders, side and front. Each player works in turn through 6 pass sequence. Players using both sides of stick to pass and receive ball.

P1 Starts with ball, sprints towards

F2 giving and receiving pass from F1

Continues towards F2 exchanging Long front pass

Carries ball around F2, stopping ball for F2, then runs diagonally away to receive return pass from F2 from behind

Finally Passing to P2 who commences his turn

Notes:

- (i) Quality of movement, speed, accuracy timing of passes are crucial.
- (ii) Stressing importance of speed of recovery from mishandling.
- (iii) Players become feeders at intervals and in rotation

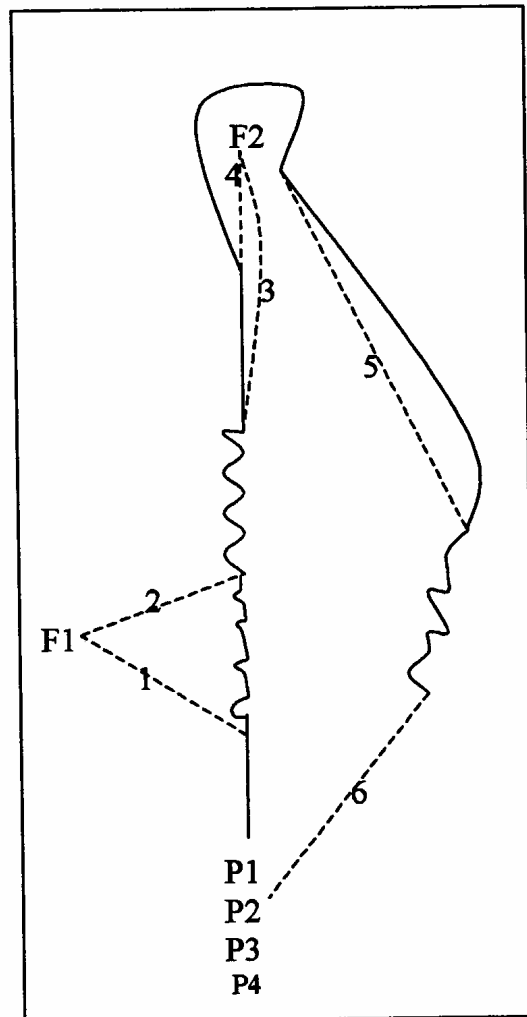

2 Retrieval of loose ball.

Situation:

Players in two lines either side of F1.

F1 gives a signal to P1 and P2 and rolls the ball along the ground between the two players.

P1 and P2 must skate to the marked area, perform a hockey stop, and then try to reach the ball before their opponent.

Player winning ball may make a shot at goal. Player not winning possession must try to block shot.

Notes:

- (i) Speed of reactions, legal use of feet, body and stick to protect and gain, prevent and protect possession.
- (ii) Effective use of Hockey Stop to make rapid change of direction.
- (iii) Stress importance of clean possession and quality of control.
- (iv) Points awarded for winning the ball and scoring.

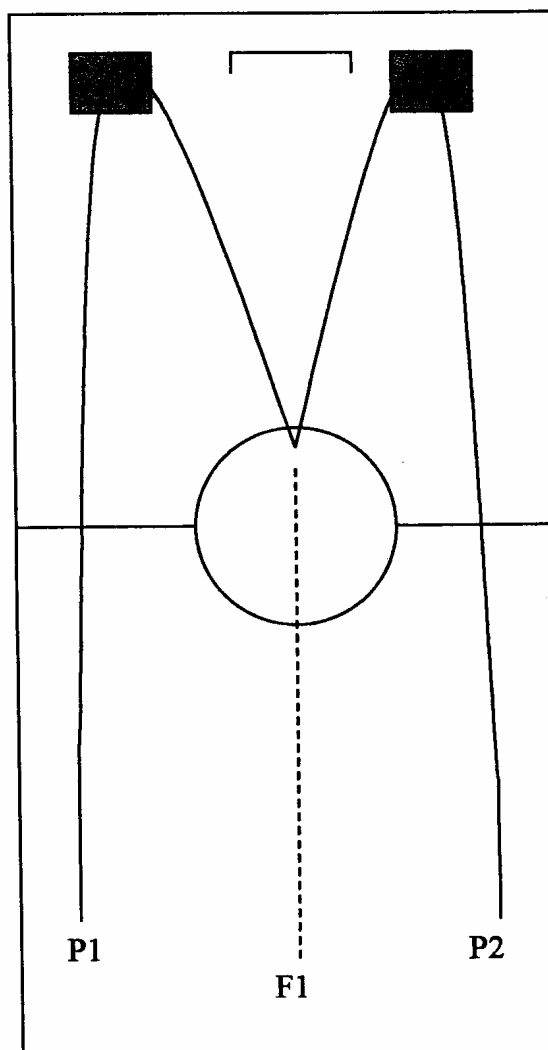

3 Attack and Defence

- Small sided conditioned competitive situation in Roller Hockey - 3v4 half court.
- 1 player is restricted to the halfway line in the centre circle. This player cannot be tackled or closed down.
- Play is restricted to half pitch. Should the ball be put out of play it will be brought back into play by the opposite team.
- Goalkeeper is on the defending side.
- Attacking team can score from anywhere within the half pitch.
- Defending team score by passing the ball to the player in the centre circle.

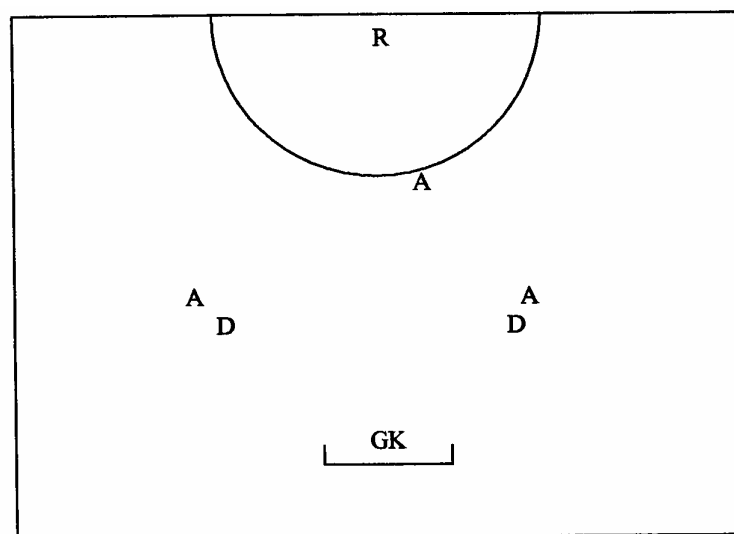

Attackers start with the ball just behind the halfway line.

Defenders must try to intercept the ball and clear it.

Attackers are awarded 1 point for an attempt at goal and 3 points for a successful shot on goal. Defenders are awarded 1 point for an interception and 3 points for effectively clearing the ball.

Assessment will take into account the candidates:

- level of accuracy, control and fluency;
- correct selection of techniques from the selection available;
- consistent success under pressure;
- understanding of principles and tactical awareness.

The conditions of the game above may be manipulated by:

- no tackling;
- the type of pass to be used;
- the number of passes made prior to an attempt at goal.

16. Water Polo

The candidate is assessed performing the acquired and developed skills of Water Polo.

The focus of the tasks will include:

- Passing/receiving
- Moving with the ball
- Shooting
- Marking/jockeying
- Intercepting
- Supporting

The level of success of the acquired and developed skill is measured through the movement phases identified in the generic Invasion game criteria.

The following are given as suggestions/exemplars of conditioned competitive situations and are not seen as being prescriptive. Centres may devise their own conditioned competitive situations.

GK

Scoring Area

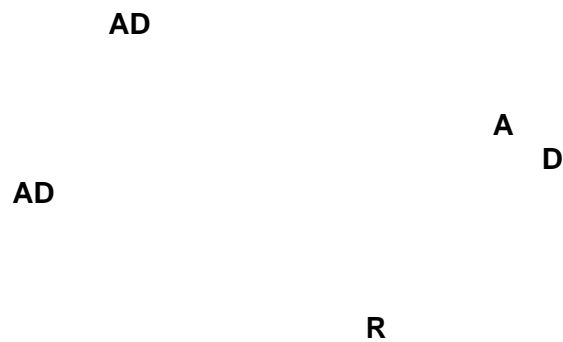

- 1 Player is restricted to an area on halfway, this player cannot be challenged or closed down.
- Play is restricted to half pitch.
- Attacking team only allowed to score from designated area.
- Defending team score by passing to restricted player.
- Possession games e.g. 3 v 3.

3.5 Net/wall Games

1. Badminton (Bad)
2. Squash (Sq)
3. Table Tennis (Tt)
4. Tennis (Te)
5. Volleyball (Vo)

Net/Wall Games - Generic criteria

Performance

The candidate is assessed in:

The performance of a range of basic and advanced skills.

The selection and application of skills and tactics.

Physical and mental fitness.

The understanding and application of rules.

The assessment should take place in conditioned competitive situations where tasks of appropriate pitch and challenge enable candidates to:

Demonstrate a range of basic and advanced skills.

Demonstrate appropriate tactical awareness.

Demonstrate an understanding and application of rules.

Be placed in rank order in terms of ability.

The level of success of their basic and advanced skills will be based on the following movement phases;

- Preparation
- Execution
- Recovery
- Result
- Overall efficiency

The level of success in appropriate tactical awareness will be based on:

- Beating/manoeuvring opponents
- Positioning
- Ball distribution
- Set pieces.

These assessment phases are used in conjunction with the following assessment criteria for the tasks of appropriate pitch and challenge in authentic contexts.

Band 1 (25-30)

The candidate demonstrates a very high level of acquired and developed skills that show a consistently high standard of accuracy, control and fluency under competitive pressure.

There is consistent successful selection and application of a wide range of advanced techniques which, under competitive pressure maintain their accuracy, fluency and control.

A wide range of appropriate strategies and tactics are successfully and consistently used by the candidate demonstrating an excellent understanding of the perceptual requirements of the activity.

The overall performance in the competitive situation is excellent and indicative of high levels of learning and understanding.

The candidate demonstrates excellent physical and mental fitness.

The candidate demonstrates an excellent understanding and application of the rules/regulations of the activity.

Band 2 (19-24)

The candidate demonstrates a high level of acquired and developed skills that show a consistently high standard of accuracy, control and fluency under competitive pressure.

There is consistent successful selection and application of a range of advanced techniques which, under competitive pressure maintain their accuracy, fluency and control.

A range of appropriate strategies and tactics are successfully and consistently used by the candidate demonstrating a good understanding of the perceptual requirements of the activity.

The overall performance in the competitive situation is very good and indicative of good levels of learning and understanding.

The candidate demonstrates good physical and mental fitness.

The candidate demonstrates a good understanding and application of the rules/regulations of the activity.

Band 3 (13-18)

The candidate demonstrates a sound level of acquired and developed skills that show a consistently good standard of accuracy, control and fluency under competitive pressure.

There is successful selection and application of a range of advanced techniques which, under competitive pressure maintain their accuracy, fluency and control.

A limited range of appropriate strategies and tactics are successfully used by the candidate demonstrating a sound understanding of the perceptual requirements of the activity.

The overall performance in the competitive situation is good and indicative of sound levels of learning and understanding.

The candidate demonstrates sound physical and mental fitness.

The candidate demonstrates a sound understanding and application of the rules/regulations of the activity.

Band 4 (7-12)

The candidate demonstrates a limited level of acquired and developed skills that show some accuracy, control and fluency under competitive pressure.

There is successful selection and application of advanced techniques which, under competitive pressure usually maintain some accuracy, fluency and control.

Some appropriate strategies and tactics are successfully used by the candidate demonstrating a limited understanding of the perceptual requirements of the activity.

The overall performance in the competitive situation is limited, inconsistent and indicative of limited learning and understanding.

The candidate demonstrates limited physical and mental fitness.

The candidate demonstrates limited understanding and application of the rules/regulations of the activity.

Band 5 (0-6)

The candidate demonstrates a poor level of acquired and developed skills that show little accuracy, control and fluency under competitive pressure.

There is an attempt to select and apply advanced techniques which, under competitive pressure maintain little accuracy, fluency and control.

Appropriate strategies and tactics are rarely used by the candidate demonstrating a poor understanding of the perceptual requirements of the activity.

The overall performance in the competitive situation is poor, inconsistent and indicative of limited learning and understanding

The candidate demonstrates inadequate levels of physical and mental fitness.

The candidate demonstrates little understanding and application of the rules/regulations of the activity.

1. Badminton

The candidate is assessed performing the acquired and developed skills of Badminton.

The focus of the tasks will include:

- Serves – short/long, forehand/backhand
- Overhead clear – forehand/backhand
- Drop shot – forehand/backhand
- Underarm clear - forehand/backhand
- Smash
- Drive - forehand/backhand
- Net shots - forehand/backhand

These will take place under competitive pressure in a singles situation.

The level of success of the acquired and developed skill is measured through the movement phases identified in the generic Net/Wall game criteria.

The following are given as suggestions/exemplars of conditioned competitive situations and are not seen as being prescriptive. Centres may devise their own conditioned competitive situations.

These will take place under competitive pressure in a one v one situation

High Serve

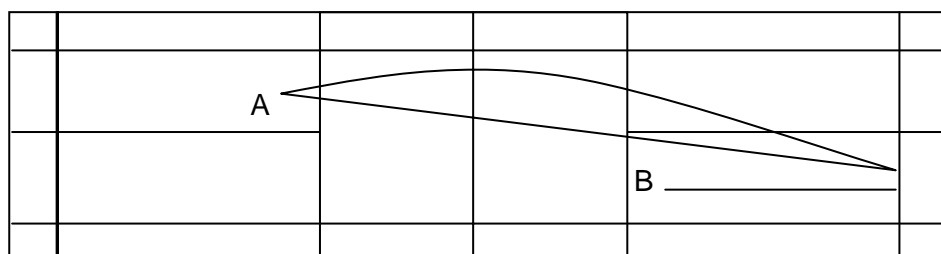

A has five high serves to B. Each time B must adopt the 'normal' receiving serve stance and position and attempt, if possible, to return A's serve.

Each serve is scored as follows:

- 4 Points B unable to return serve
- 3 Points B returns serve but A is able to attack return
- 2 Points B returns serve but A has to defend
- 1 Point Serve is good but B returns and kills

Net Play

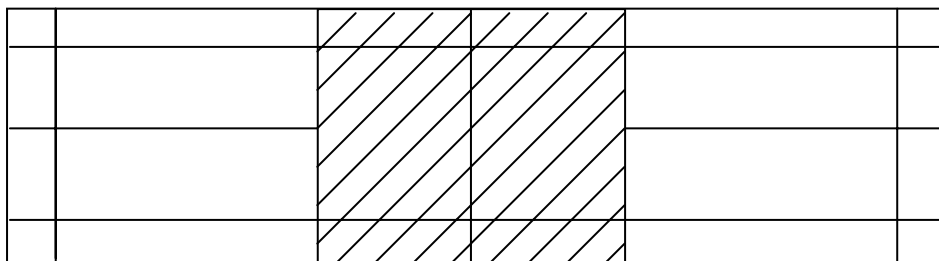

Only net shots to be used.
 Play confined to area between service lines.
 Twenty points to be played for.
 Usual rules relating to change of service and scoring.

Overhead Clear

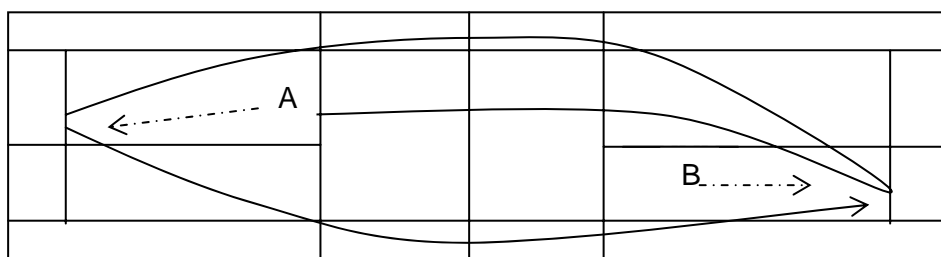

From the normal serving position A high serves to B who then forehand overhead clears to the diagonally opposite back court from tramlines. A returns with a forehand overhead clear to the diagonally opposite back court from tramlines. This rally continues and a point is won when either player:

- (i) Fails to return the shuttle.
- (ii) Return falls short of backcourt tramlines.
- (iii) Return falls beyond backcourt tramlines.
- (iv) Fails to play forehand overhead clear.

Overhead clear to the diagonally opposite back court from tramlines. This rally continues and a point is won when either player:

- (i) Fails to return the shuttle.
- (ii) Return falls short of backcourt tramlines.

- (iii) Return falls beyond backcourt tramlines.
- (iv) Fails to play forehand overhead clear.

Winner of point serves to start to next rally.

Stroke Restriction

E.g. Underarm shots only to be used in a singles game. Normal rules apply apart from scoring when player who wins the rally wins one point. Round robin competition, each game best of five points.

Court Restriction

E.g. Singles conditioned game to develop length and width.

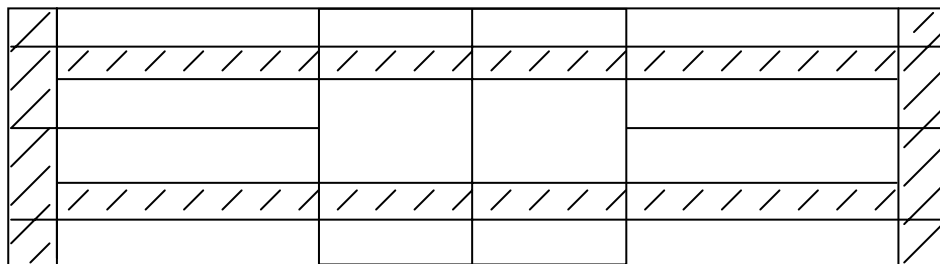

Only shots in the shaded area are good.

2. Squash

The candidate is assessed performing the acquired and developed skills of Squash.

The focus of the tasks will include:

- Service – forehand/backhand
- Drives – forehand/backhand
- Volleys – forehand/backhand
- Underarm clear - forehand/backhand
- Boasts
- Lob

These will take place under competitive pressure in a singles situation.

The level of success of the acquired and developed skill is measured through the movement phases identified in the generic Net/Wall game criteria.

3. Table Tennis

The candidate is assessed performing the acquired and developed skills of Table Tennis.

The focus of the tasks will include:

- Service – forehand/backhand (varied length, speed and direction)
- Service return (varied angles, range of target areas, movement)
- Drives – forehand/backhand
- Push – forehand/backhand
- Block
- Drop shot
- Topspin – forehand/backhand
- Backspin – forehand/backhand

These will take place under competitive pressure in a singles situation.

The level of success of the acquired and developed skill is measured through the movement phases identified in the generic Net/Wall game criteria.

The following are given as suggestions/exemplars of conditioned competitive situations and are not seen as being prescriptive. Centres may devise their own conditioned competitive situations.

These will take place under competitive pressure in a one v one situation.

- Service
 - Low net trajectory, varied length, speed and direction
(include long and fast, short and slow, short plus bounce at end of table)
 - Combination of strokes, range of target areas, movement.
- Service Return
 - Push – from a short serve; Drive – from a long serve
(include varied angles, direction, exploitation of cross over point)
- Basic Strokes
 - Backhand push
 - Forehand drive
 - Backhand drive
 - Forehand push
 } & combinations of these
- Advanced strokes
 - Forehand and Backhand Topspin
 - Forehand and Backhand Backspin
 - Block
 - Drop shot

Table Tennis

Service and Return

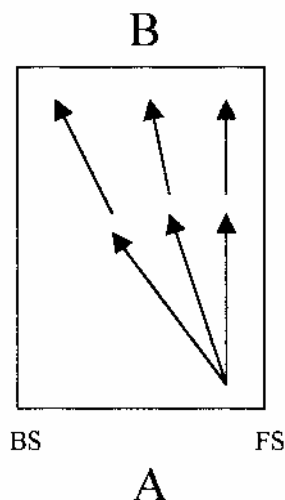

Player A

Candidate serves with varied length, speed and direction from both forehand and backhand sides.

Player B

Candidate returns variety of serves showing varied angles and direction, to include push return and drive return.

Player A to perform 24 serves and then swap with player B.

Basic Strokes

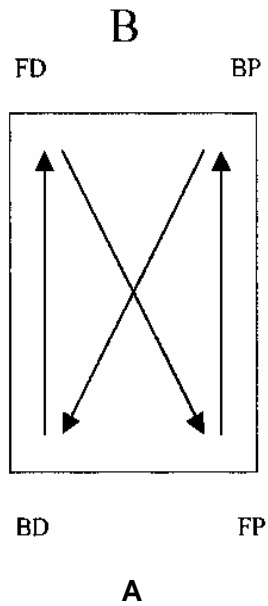

Player A

Performs backhand drive down the line followed by forehand push down the line.

Player B

Performs backhand push diagonally followed by forehand drive diagonally.

After 30 successful shots players A and B swap over.

Spin

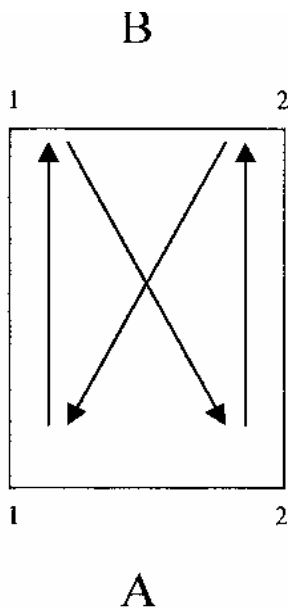

Player A

1. Backhand topspin down the line.
 2. Forehand topspin down the line.
- Player B – block return.

Player A

1. Backhand backspin down the line.
 2. Forehand backspin down the line.
- Player B – block return.

Player A

1. Forehand backspin diagonally.
 2. Backhand backspin diagonally.
- Player B - block return.

Player A

1. Forehand topspin diagonally.
 2. Backhand topspin diagonally.
- Player B – block return.

After sufficient successful shots players A and B swap roles.

Block/Drop combination

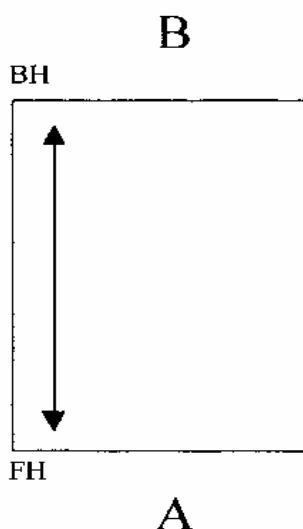

Player A serves.

Players A and B play 3 shots each in area shown, when A reaches fourth shot it should become open ended i.e. any shot to open up and continue the rally.

Players should include block and drop shots and aim to win the rally.

Player A serves five times and then A and B swap roles.

4. Tennis

The candidate is assessed performing the acquired and developed skills of Tennis.

The focus of the tasks will include:

- Serves - First and second serves, Flat, slice, top spin.
- Ground strokes –forehand/backhand/top spin
- Volley – forehand/backhand
- Overhead shots
- Lob – defensive, offensive.

These will take place under competitive pressure in a singles situation.

The level of success of the acquired and developed skill is measured through the movement phases identified in the generic Net/Wall game criteria.

The following are given as suggestions/exemplars of conditioned competitive situations and are not seen as being prescriptive. Centres may devise their own conditioned competitive situations.

These will take place under competitive pressure in a one v one situation.

Court Restriction

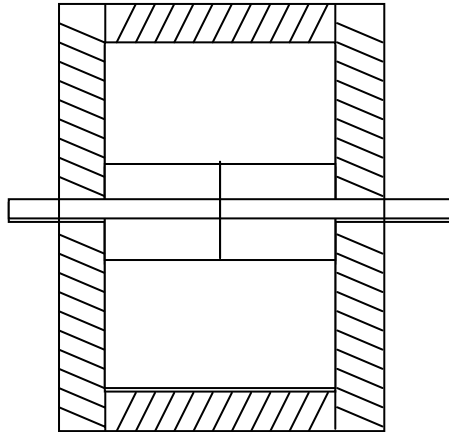

SINGLES / / / /
DOUBLES \ \ \ \

Adjust scoring system so that players gain one point for winning the normal rally, three points for playing a shot into the shaded area and five points for playing a winning shot into the shaded area.

Shot Restriction

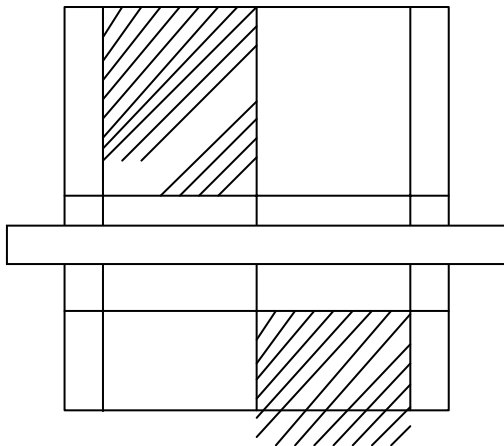

Forehand drive is the only permitted stroke after the serve. Ball must land in the shaded area or is 'out'.

Half cover singles (shaded area)

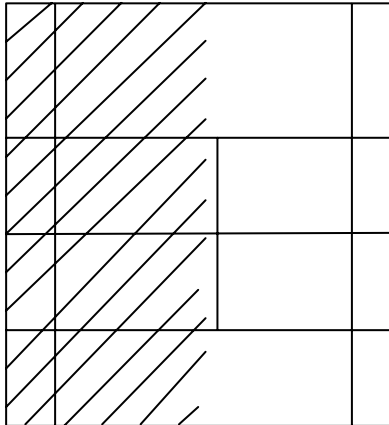

Scoring

Winning – 1 pt No volley played
2 pts with volley played
3 pts overhead shot played

Lose 0 pts.

5. Volleyball

The candidate is assessed performing the acquired and developed skills of Volleyball.

The focus of the tasks will include:

Overhead techniques

- Service – tennis, float, jump-float, jump topspin. (+ positional understanding)
- Volley and setting
- Block
- Smash – variations of drive.

Under-hand techniques

- Dig
- Emergency retrieve techniques
- Service receive

Control of ball

Front court switching

The level of success of the acquired and developed skill is measured through the movement phases identified in the generic Net/Wall game criteria.

3.6 Striking/Fielding Games

1. Baseball (Bb)
2. Cricket (Cr)
3. Rounders (Ro)

Striking/Fielding Games -Generic criteria

Performance

The candidate is assessed in:

The performance of a range of basic and advanced skills.

The selection and application of skills and tactics

Physical and mental fitness

The understanding and application of rules.

The assessment should take place in conditioned competitive situations where tasks of appropriate pitch and challenge enable candidates to:

Demonstrate a range of basic and advanced skills

Demonstrate appropriate tactical awareness

Demonstrate an understanding and application of rules

Be placed in rank order in terms of ability.

The level of success of their basic and advanced skills will be based on the following movement phases;

- Preparation
- Execution
- Recovery
- Result
- Overall efficiency

The level of success in appropriate tactical awareness will be based on:

- Beating opponents
- Support/positioning
- Ball distribution
- Field settings

These assessment phases are used in conjunction with the following assessment criteria for the tasks of appropriate pitch and challenge in authentic contexts.

Band 1 (25-30)

The candidate demonstrates a very high level of acquired and developed skills that show a consistently high standard of accuracy, control and fluency under competitive pressure.

There is consistent successful selection and application of a wide range of advanced techniques which, under competitive pressure maintain their accuracy, fluency and control.

A wide range of appropriate strategies and tactics are successfully and consistently used by the candidate demonstrating an excellent understanding of the perceptual requirements of the activity.

The overall performance in the competitive situation is excellent and indicative of high levels of learning and understanding.

The candidate demonstrates excellent physical and mental fitness.

The candidate demonstrates an excellent understanding and application of the rules/regulations of the activity.

Band 2 (19-24)

The candidate demonstrates a high level of acquired and developed skills that show a consistently high standard of accuracy, control and fluency under competitive pressure.

There is consistent successful selection and application of a range of advanced techniques which, under competitive pressure maintain their accuracy, fluency and control.

A range of appropriate strategies and tactics are successfully and consistently used by the candidate demonstrating a good understanding of the perceptual requirements of the activity.

The overall performance in the competitive situation is very good and indicative of good levels of learning and understanding.

The candidate demonstrates good physical and mental fitness.

The candidate demonstrates a good understanding and application of the rules/regulations of the activity.

Band 3 (13-18)

The candidate demonstrates a sound level of acquired and developed skills that show a consistently good standard of accuracy, control and fluency under competitive pressure.

There is successful selection and application of a range of advanced techniques which, under competitive pressure maintain their accuracy, fluency and control.

A limited range of appropriate strategies and tactics are successfully used by the candidate demonstrating a sound understanding of the perceptual requirements of the activity.

The overall performance in the competitive situation is good and indicative of sound levels of learning and understanding.

The candidate demonstrates sound physical and mental fitness.

The candidate demonstrates a sound understanding and application of the rules/regulations of the activity.

Band 4 (7-12)

The candidate demonstrates a limited level of acquired and developed skills that show some accuracy, control and fluency under competitive pressure.

There is successful selection and application of advanced techniques which, under competitive pressure usually maintain some accuracy, fluency and control.

Some appropriate strategies and tactics are successfully used by the candidate demonstrating a limited understanding of the perceptual requirements of the activity.

The overall performance in the competitive situation is limited, inconsistent and indicative of limited learning and understanding.

The candidate demonstrates limited physical and mental fitness.

The candidate demonstrates limited understanding and application of the rules/regulations of the activity.

Band 5 (0-6)

The candidate demonstrates a poor level of acquired and developed skills that show little accuracy, control and fluency under competitive pressure.

There is an attempt to select and apply advanced techniques which, under competitive pressure maintain little accuracy, fluency and control.

Appropriate strategies and tactics are rarely used by the candidate demonstrating a poor understanding of the perceptual requirements of the activity.

The overall performance in the competitive situation is poor, inconsistent and indicative of limited learning and understanding

The candidate demonstrates inadequate levels of physical and mental fitness.

The candidate demonstrates little understanding and application of the rules/regulations of the activity.

1. Baseball

The candidate is assessed performing the acquired and developed skills of Baseball.

Candidates will be assessed in Batting or Pitching and Fielding.

The focus of the tasks will include:

1. Batting
Striking – left, right, straight, high, low.
Running between posts
2. Pitching
Fast, slow, curve, spin,
3. Fielding
Approaching ball
Stopping ball – short and long barriers.
Catching – close and deep
Pick up and throw – underarm/overarm.

The level of success of the acquired and developed skill is measured through the movement phases identified in the generic Striking game criteria.

The following are given as suggestions/exemplars of conditioned competitive situations and are not seen as being prescriptive. Centres may devise their own conditioned competitive situations.

1. FIELDING

(a) Pick up and throw

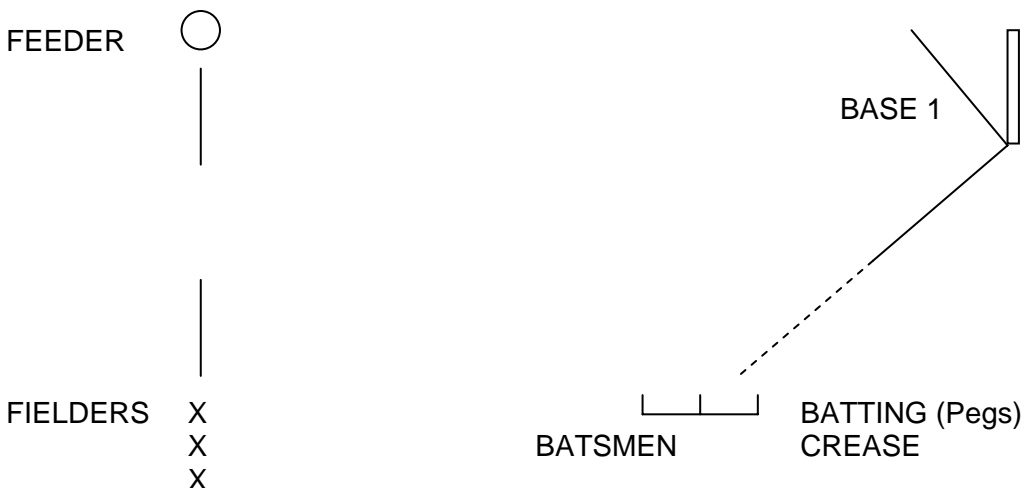

Feeder rolls ball towards fielder. Fielder runs in, attacking pick up either short barrier or one handed pick up and throw at Base 1.

Batsman has to reach Base 1.

(b) Long barrier fielding and throwing in.

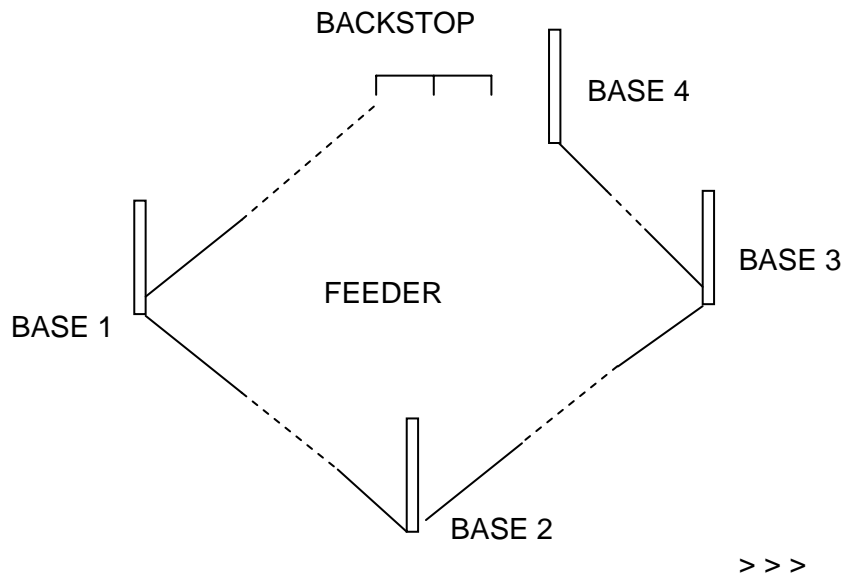

X X X

> > >

Feeder hits ball out between Bases 1 and 3.

X X X Fielders have to do a long barrier and throw to Base 1, 2, 3 or 4.

> > > Fielders have to back up X X X

- Variation
- i) change sides for pick up
 - ii) ball in air and at varying speeds.

BATTING

Batsman has target area for particular strokes.

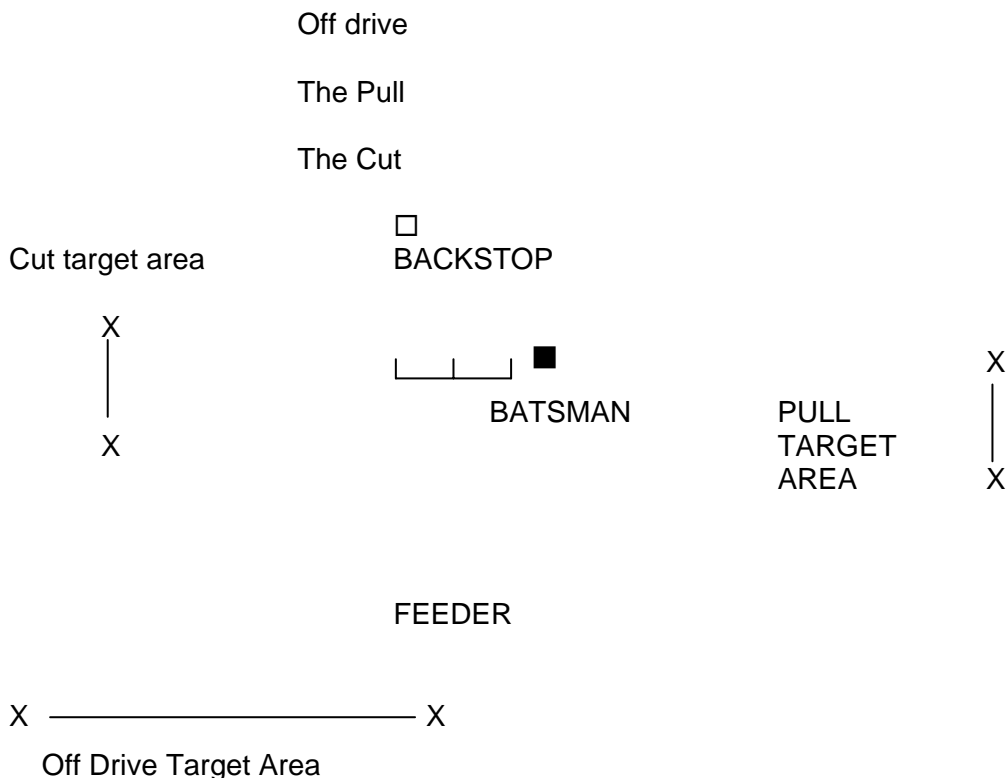

PITCHING

Using a wall, place targets at heights where you would expect a 'good' ball to pass the batting crease.

WALL



Points awarded for hitting target area

- Variations:
- different type of ball to be pitched, speed and pace, outswinger, inswinger.
 - Pitcher, Backstop, Base 1 triangle (Pitcher pitches, backstop receives and throws to Base 1).

2. Cricket

The candidate is assessed performing the acquired and developed skills of Cricket.

Candidates will be assessed in Batting or Bowling and Fielding.

The focus of the tasks will include:

Batting

- Defensive shots off front and back foot.
- Drives off front and back foot
- Cut/Glance shots
- Pull shots
- Hook shots
- Appropriate use of protective equipment.

Bowling

- Fast or Medium or Spin
- Accuracy in terms of Line and Length

Fielding

- Approaching ball
- Stopping ball – short and long barriers.
- Catching – close and deep
- Pick up and throw – underarm/overarm.

The level of success of the acquired and developed skill is measured through the movement phases identified in the generic Striking game criteria.

The following are given as suggestions/exemplars of conditioned competitive situations and are not seen as being prescriptive. Centres may devise their own conditioned competitive situations.

1. Fielding
 (a) Pick up and throw

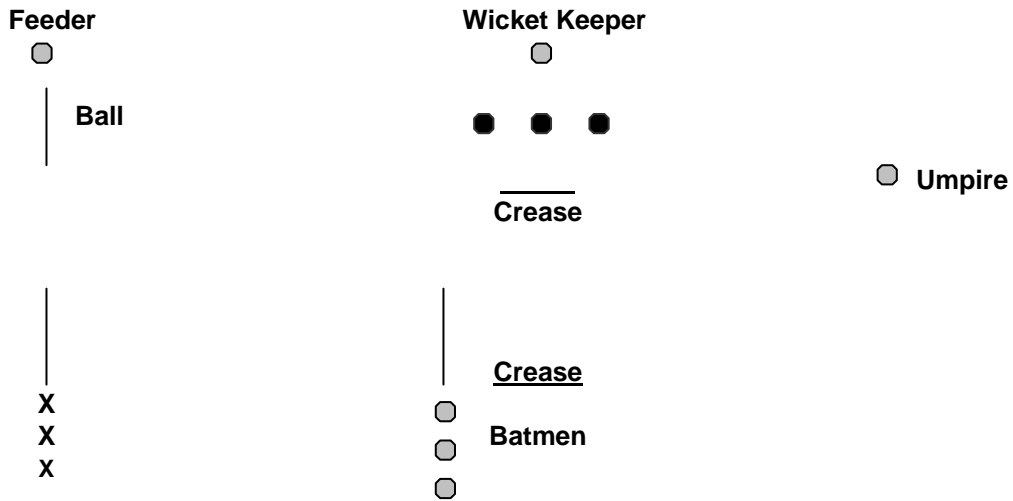

Fielders

Feeder rolls ball towards fielder. Fielder runs in, attacking pick up either short barrier or one handed pick up and throw at stumps.

Batter has to slide bat over the crease before fielder hit stumps.

(b) Long barrier fielding and throwing In

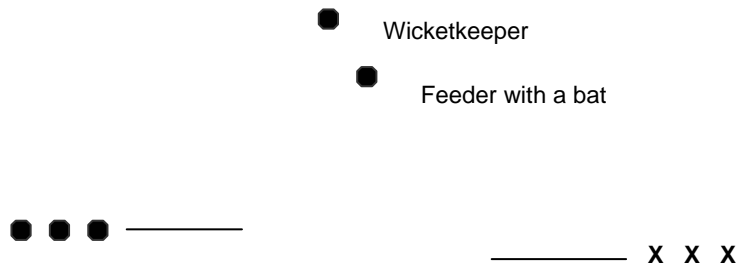

Keeper throws ball to feeder who hits ball out between the two fielding lines.

● ● ● Fielders have to do a long barrier, pick up and throw over the stumps to the keeper.

XXX Fielders have to back up ● ● ●.

- Variation
- (i) change sides for pick up
 - (ii) ball in air and at varying speeds.

2. Batting

Using Kwick cricket balls or incrediballs

Batsman has target areas for particular strokes.

Off drive (off front foot)

The pull

The square cut

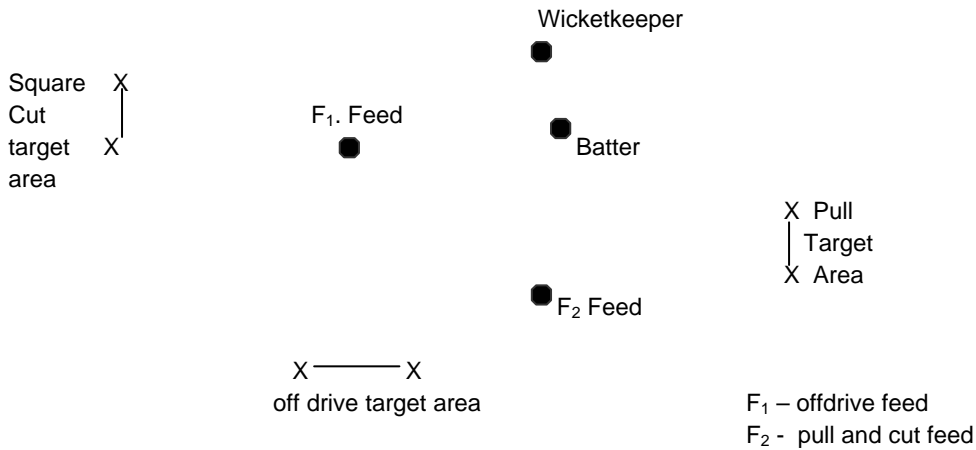

Fielders are placed in target area, who have to return ball to either wicket and try to run the batsman out. Batsman scores runs for hitting target area as well as actual runs between wickets.

3. Bowling

Place targets down where you would expect a good length ball to pitch. This will vary according to the type of ball to be bowled – seam, spin, swing.

- Points awarded for
- (i) Hitting target
 - (ii) Hitting wickets

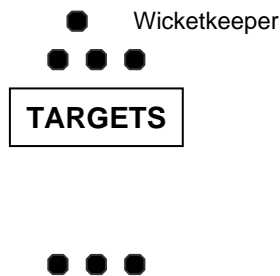

- Variation
- (i) Play passive batsman – does not play ball
 - (ii) Play to wicketkeeper and umpire

3. Rounders

The candidate is assessed performing the acquired and developed skills of Rounders.

Candidates will be assessed in Batting or Bowling and Fielding.

The focus of the tasks will include:

1. Batting

- Placement of shot in relation to fielders
- Striking – left, right, straight, high, low.
- Running between bases and cornering technique.

2. Bowling

- Pace of bowling – fast/slow
- Accuracy in relation to no balls.
- Direction of bowling
- Use of spin
- Placement of fielders

3. Fielding

- Approaching ball
- Attacking and defensive ground fielding
- Stopping ball – short and long barriers.
- Catching – close and deep
- Pick up and throw – underarm/overarm.

The level of success of the acquired and developed skill is measured through the movement phases identified in the generic Striking game criteria.

The following are given as suggestions/exemplars of conditioned competitive situations and are not seen as being prescriptive. Centres may devise their own conditioned competitive situations.

Rounders

1. Fielding

(a) Pick up and throw

Feeder

○



Ball

Post Player

○

○ Umpire



X

○

X

○

Batters

X

○

Fielders

Feeder rolls ball towards fielder. Fielder runs in, attacking pick up either short barrier or one-handed pick up and throw at post player.

Batter has to hit post before fielder stumps post.

(b) Long barrier fielding and throwing in

○ Backstop

○ Feeder with a bat

○ Post

Player

○ ○ ○ ———

————— X

X X

Backstop throws ball to feeder who hits ball out between the two fielding lines.

• • • Fielders have to do a long barrier, pick up and throw to the post player.

X X X Fielders have to back up • • •

Variation (i) change sides for pick up
(ii) ball in air and at varying speeds

3.7 Target Games

1. Archery (Ar)
2. Golf (Go)
3. Flat Green Bowls (Gb)

Target Games – Generic criteria

Performance

The candidate is assessed in:

The performance of a range of basic and advanced skills.

The selection and application of skills and tactics

Physical and mental fitness

The understanding and application of rules.

The assessment should take place in conditioned competitive situations where tasks of appropriate pitch and challenge enable candidates to:

Demonstrate a range of basic and advanced skills

Demonstrate appropriate tactical awareness

Demonstrate an understanding and application of rules

Be placed in rank order in terms of ability.

The level of success of their basic and advanced skills will be based on the following movement phases:

- Preparation
- Execution
- Recovery
- Result
- Overall efficiency

The level of success in appropriate tactical awareness will be based on:

Accuracy

Selection and appropriate use of equipment.

Achievement of goals.

These assessment phases are used in conjunction with the following assessment criteria for the tasks of appropriate pitch and challenge in authentic contexts.

Band 1 (25-30)

The candidate demonstrates a very high level of acquired and developed skills that show a consistently high standard of accuracy, control and fluency under competitive pressure.

There is consistent successful selection and application of a wide range of advanced techniques which, under competitive pressure maintain their accuracy, fluency and control.

A wide range of appropriate strategies and tactics are successfully and consistently used by the candidate demonstrating an excellent understanding of the perceptual requirements of the activity.

The overall performance in the competitive situation is excellent and indicative of high levels of learning and understanding.

The candidate demonstrates excellent physical and mental fitness.

The candidate demonstrates an excellent understanding and application of the rules/regulations of the activity.

Band 2 (19-24)

The candidate demonstrates a high level of acquired and developed skills that show a consistently high standard of accuracy, control and fluency under competitive pressure.

There is consistent successful selection and application of a range of advanced techniques which, under competitive pressure maintain their accuracy, fluency and control.

A range of appropriate strategies and tactics are successfully and consistently used by the candidate demonstrating a good understanding of the perceptual requirements of the activity.

The overall performance in the competitive situation is very good and indicative of good levels of learning and understanding.

The candidate demonstrates good physical and mental fitness.

The candidate demonstrates a good understanding and application of the rules/regulations of the activity.

Band 3 (13-18)

The candidate demonstrates a sound level of acquired and developed skills that show a consistently good standard of accuracy, control and fluency under competitive pressure.

There is successful selection and application of a range of advanced techniques which, under competitive pressure maintain their accuracy, fluency and control.

A limited range of appropriate strategies and tactics are successfully used by the candidate demonstrating a sound understanding of the perceptual requirements of the activity.

The overall performance in the competitive situation is good and indicative of sound levels of learning and understanding.

The candidate demonstrates sound physical and mental fitness.

The candidate demonstrates a sound understanding and application of the rules/regulations of the activity.

Band 4 (7-12)

The candidate demonstrates a limited level of acquired and developed skills that show some accuracy, control and fluency under competitive pressure.

There is successful selection and application of advanced techniques which, under competitive pressure usually maintain some accuracy, fluency and control.

Some appropriate strategies and tactics are successfully used by the candidate demonstrating a limited understanding of the perceptual requirements of the activity.

The overall performance in the competitive situation is limited, inconsistent and indicative of limited learning and understanding.

The candidate demonstrates limited physical and mental fitness.

The candidate demonstrates limited understanding and application of the rules/regulations of the activity.

Band 5 (0-6)

The candidate demonstrates a poor level of acquired and developed skills that show little accuracy, control and fluency under competitive pressure.

There is an attempt to select and apply advanced techniques which, under competitive pressure maintain little accuracy, fluency and control.

Appropriate strategies and tactics are rarely used by the candidate demonstrating a poor understanding of the perceptual requirements of the activity.

The overall performance in the competitive situation is poor, inconsistent and indicative of limited learning and understanding

The candidate demonstrates inadequate levels of physical and mental fitness.

The candidate demonstrates little understanding and application of the rules/regulations of the activity.

1. Archery

The candidate is assessed performing the acquired and developed skills of archery.

The focus of the tasks will include:

- Portsmouth round - Five dozen arrows at twenty yards on a 60 cm. face. 10 zone scoring.
- Demonstration of correct stance
- Demonstration of consistent DFL and ESAR.
- Demonstration of personal shot sequence.
- Selection of appropriately spined arrows for draw weight of bow.
- Knowledge of personal equipment and its component parts.
- Application of the safety rules ensuring the safety of the candidate, other participants and the general public.

The level of success of the acquired and developed skill is measured through the movement phases identified below:

- Ability to shoot in details and ends of 3/6 as appropriate.

The level of success in appropriate tactical awareness will be based on:

- Knowledge of procedures for FITA and GNAS indoor tournaments.
- Recognition of equipment issues that could affect performance.
- Tactics to be used when shooting on 3 spot face.

These assessment criteria will be used in conjunction with the generic assessment criteria for Target Games.

2. Golf

The candidate is assessed performing the acquired and developed skills of Golf.

The focus of the tasks will include:

- Club selection and distance
- Stroke action and target accuracy.
- Driving
- Mid irons
- Approach shots
- Putting
- Bunker play.

The level of success of the acquired and developed skill is measured through the movement phases identified in the generic Target game criteria.

3. Flat Green Bowls

The candidate is assessed performing the acquired and developed skills of Flat Green Bowls.

The focus of the tasks will include:

- Short mat – backhand, forehand
- Long mat – backhand, forehand
- Blocking

The level of success of the acquired and developed skill is measured through the movement phases identified in the generic Target game criteria.

The following are given as suggestions/exemplars of conditioned competitive situations and are not seen as being prescriptive. Centres may devise their own conditioned competitive situations.

Using three mats four bowls each, both leads play alternately as follows:

- 1st bowl – backhand from long mat
- 2nd bowl – forehand from medium mat
- 3rd bowl – backhand from short mat
- 4th bowl – forehand from long mat

No successive bowls are played either from the same mat or on the same hand.

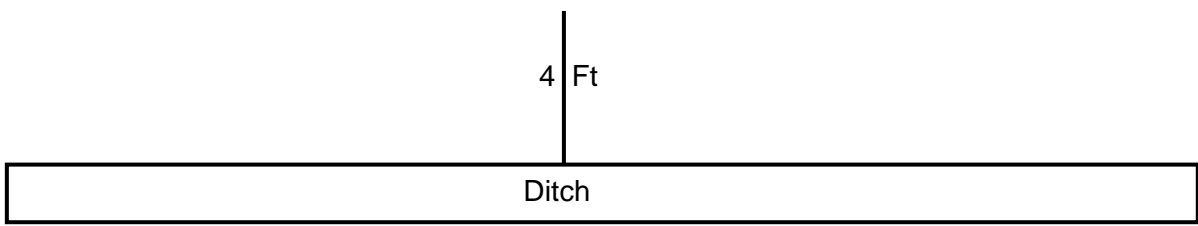
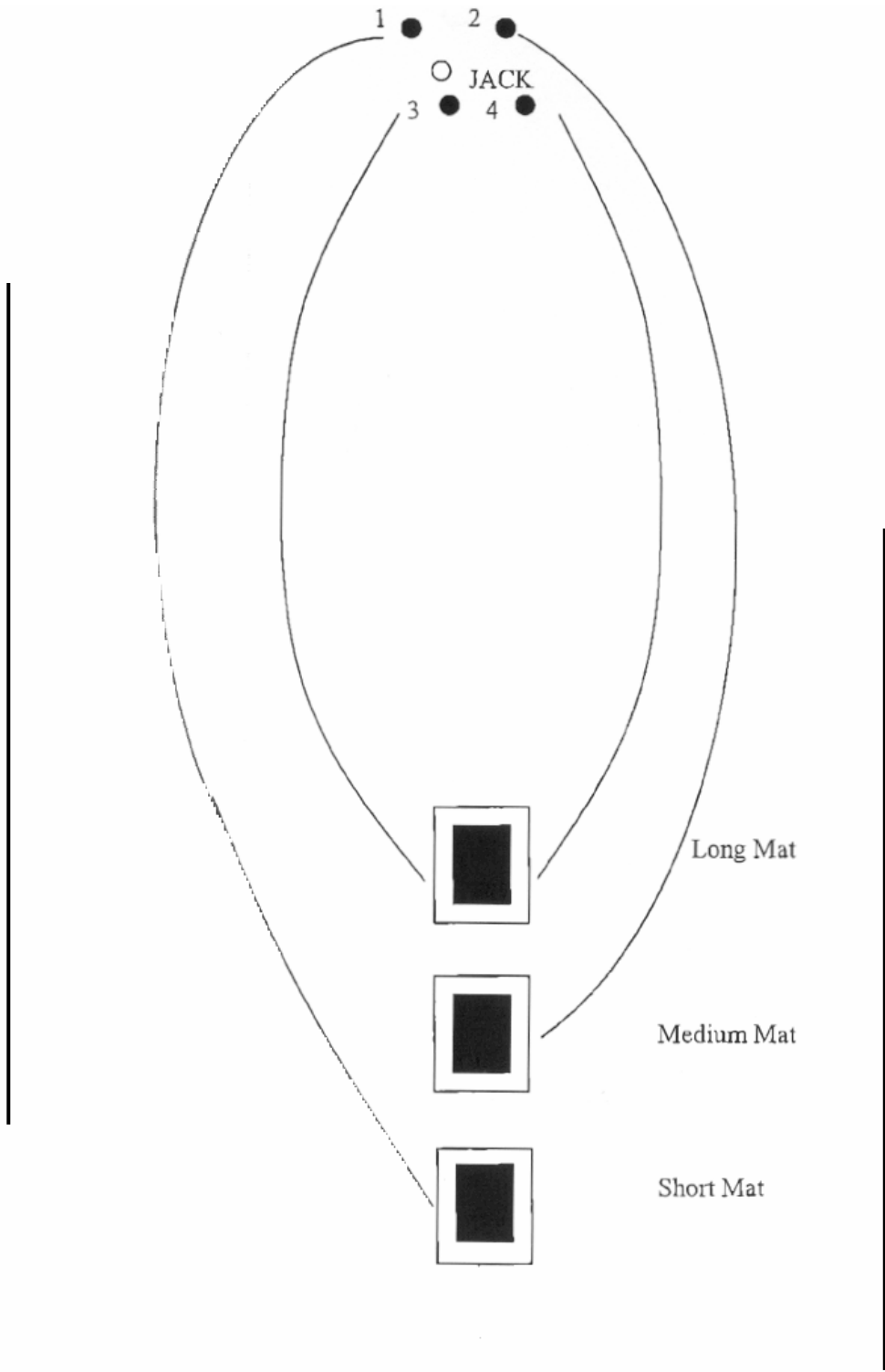

Keeping the good hand

The object is to find a path to the Jack both outside and inside a blocking bowl.

In this 'Solo' practice place a space bowl in the good hand two to three feet short of the Jack.

The object is to give your skip as many bowls out of four closer to the Jack than the space bowl trying to play two on the outside line and two inside.

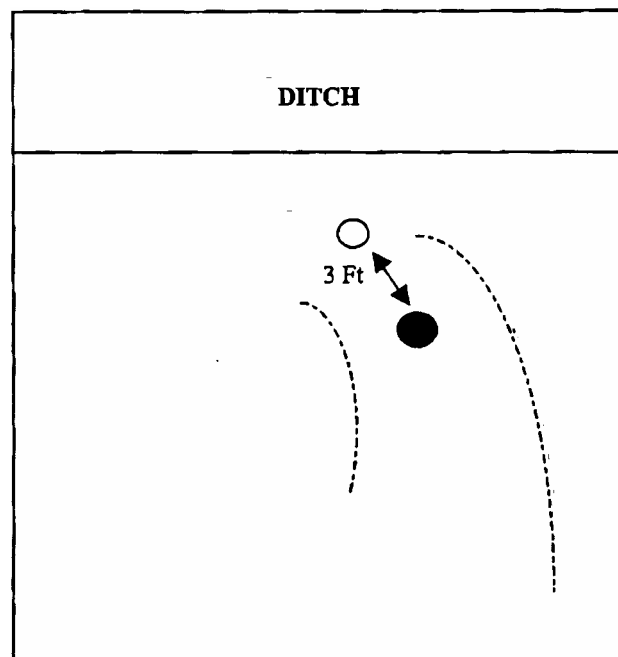

Delivering the Jack

Two leads use two jacks each with four mats laid on rink in the formation as shown. Points are scored as per normal for bowls. The jack finishing nearest the target mat with each player scoring for a jack that finishes on the target mat.

- First End** Each lead casts alternately from mat 1-3, then from mat 2-3
Second End Each casts alternately from 3-1, then from 4-1
Third End Each casts alternately from 1-4, then from 1-3
Fourth End Each casts alternately from 3-2, then from 4-2

Cycle can be repeated as required giving all combinations both ways of long/short mats and long/short jacks.

MOVE MATS AS REQUIRED

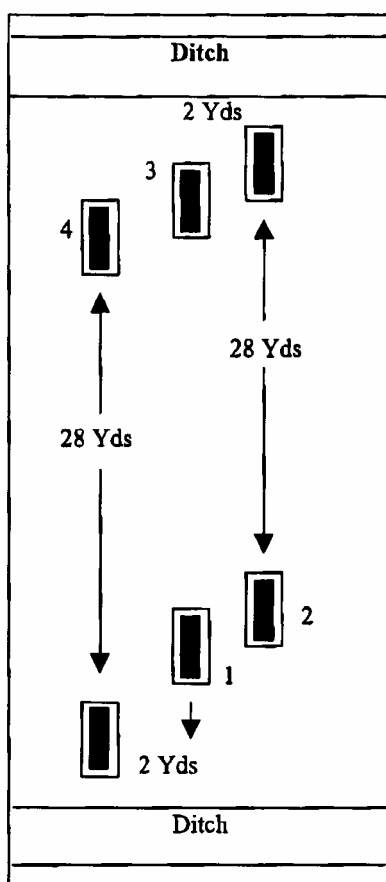

Varying Hand and Length

Here, two leads practice competitively against each other with radical adjustments. At the finish of the end one shot could be scored at the short and medium jacks and two shots on the long jack. Use four bowls each delivering alternately.

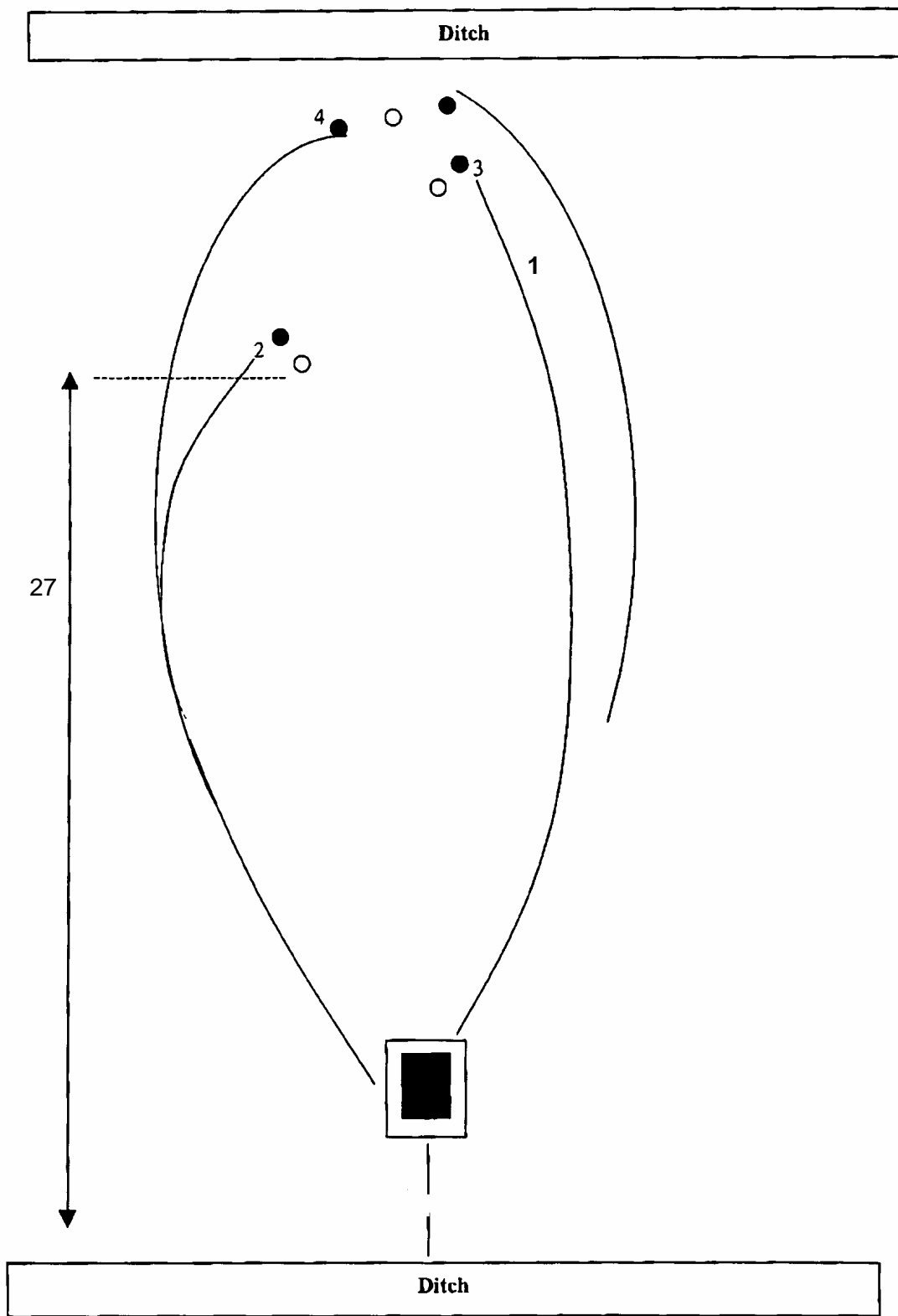

- | | | |
|------------------------|-------------------------|------|
| 1 st Bowl - | Forehand to long jack | |
| 2 nd Bowl - | Backhand to short jack | |
| 3 rd Bowl - | Forehand to medium jack | 4 Ft |
| 4 th Bowl - | Backhand to long jack | |

No successive bowls are played either on same hand or to same length.

3.8 Gymnastic Activities

1. Diving (Div)
2. Gymnastics (Gym)
3. Ice (figure) Skating (ISk)
4. Rhythmic Gymnastics (Rg)
5. Sports Acrobatics (Saw)
6. Trampolining (Tr)

Gymnastic activities – Generic criteria

Performance

The candidate is assessed in:

The performance of a range of basic and advanced skills.

The selection and application of skills and tactics

Physical and mental fitness

The understanding and application of rules.

The assessment should take place in conditioned competitive situations where tasks of appropriate pitch and challenge enable candidates to:

Demonstrate a range of basic and advanced skills

Demonstrate appropriate tactical awareness

Demonstrate an understanding and application of rules

Be placed in rank order in terms of ability.

The level of success of their basic and advanced skills will be based on the following movement phases together with those appropriate to the activity:

- Shape
- Form
- Consistency
- Control

The level of success in appropriate tactical awareness will be based on:

- Beating opponents
- Maximising performance

Candidates will produce a written programme prior to assessment and moderation which outlines the skills they will perform.

These assessment phases are used in conjunction with the following assessment criteria for the tasks of appropriate pitch and challenge in authentic contexts.

Band 1 (25-30)

The candidate demonstrates a very high level of acquired and developed skills that show a consistently high standard of accuracy, control and fluency under performance pressure.

There is consistent successful selection and application of a wide range of advanced techniques which, under performance pressure, maintain their accuracy, fluency and control.

A wide range of appropriate strategies, tactics, choreographical/compositional ideas are successfully and consistently used by the candidate demonstrating an excellent understanding of the perceptual requirements of the activity.

The overall standard in the performance situation is excellent and indicative of high levels of learning and understanding.

The candidate demonstrates excellent physical and mental fitness.

The candidate demonstrates an excellent understanding and application of the rules/regulations/conventions of the activity.

Band 2 (19-24)

The candidate demonstrates a high level of acquired and developed skills that show a consistently high standard of accuracy, control and fluency under performance pressure.

There is consistent successful selection and application of a range of advanced techniques which, under performance pressure, maintain their accuracy, fluency and control.

A range of appropriate strategies, tactics, choreographical/compositional ideas are successfully and consistently used by the candidate demonstrating a good understanding of the perceptual requirements of the activity.

The overall standard in the performance situation is very good and indicative of good levels of learning and understanding.

The candidate demonstrates good physical and mental fitness.

The candidate demonstrates a good understanding and application of the rules/regulations/conventions of the activity.

Band 3 (13-18)

The candidate demonstrates a sound level of acquired and developed skills that show a consistently good standard of accuracy, control and fluency under performance pressure.

There is successful selection and application of a range of advanced techniques which, under performance pressure, maintain their accuracy, fluency and control.

A limited range of appropriate strategies, tactics, choreographical/compositional ideas are successfully used by the candidate demonstrating a sound understanding of the perceptual requirements of the activity.

The overall standard in the performance situation is good and indicative of sound levels of learning and understanding.

The candidate demonstrates sound physical and mental fitness.

The candidate demonstrates a sound understanding and application of the rules/regulations/conventions of the activity.

Band 4 (7-12)

The candidate demonstrates a limited level of acquired and developed skills that show some accuracy, control and fluency under performance pressure.

There is successful selection and application of advanced techniques which, under performance pressure, usually maintain some accuracy, fluency and control.

Some appropriate strategies, tactics, choreographical/compositional ideas are successfully used by the candidate demonstrating a limited understanding of the perceptual requirements of the activity.

The overall standard in the performance situation is limited, inconsistent and indicative of limited learning and understanding.

The candidate demonstrates limited physical and mental fitness.

The candidate demonstrates limited understanding and application of the rules/regulations/conventions of the activity.

Band 5 (0-6)

The candidate demonstrates a poor level of acquired and developed skills that show little accuracy, control and fluency under performance pressure.

There is an attempt to select and apply advanced techniques which, under performance pressure, maintain little accuracy, fluency and control.

Appropriate strategies, tactics, choreographical/ compositional ideas are rarely used by the candidate demonstrating a poor understanding of the perceptual requirements of the activity.

The overall standard in the performance situation is poor, inconsistent and indicative of limited learning and understanding

The candidate demonstrates inadequate levels of physical and mental fitness.

The candidate demonstrates little understanding and application of the rules/regulations/conventions of the activity.

1. Diving

The candidate is assessed performing the acquired and developed skills of Diving.

The focus of the tasks will be:

A six dive list off either the 1metre, 3metre or 5metre board.

This list is made up from the elements identified below with at least one from each section.

All dives can be performed in the tuck, pike or straight position.

Forward rotation

- forward dive
- forward somersault
- forward one and a half somersaults

Inwards rotation

- backward jump with full arm-swing
- inward dive
- inward somersault
- inward one and a half somersaults

Backwards rotation

- backward dive
- backward somersault
- backward one and a half somersaults

Reverse rotation

- forward jump with full arm-swing
- reverse dive
- reverse somersault
- reverse one and a half somersaults

Assessment is based on performance in a conditioned competitive situation where the candidate performs the acquired and developed skills under pressure in a strategic situation.

The level of success of the acquired and developed skill is measured through the movement phases stated below:

- Take off
consistency in height
correct posture
control in the production of early movement
overall efficiency
- Shape
aesthetic quality
body posture/positioning
- Control
success in both the list of dives as a whole and the individual dives
- Entry
body posture
minimal splash
aesthetic quality
- Consistency
aesthetic quality
quality of the individual dives and the overall list of dives in relation to amplitude, timing and spatial awareness

These assessment criteria are used in conjunction with the generic assessment criteria for Gymnastic activities.

2. Gymnastics

The candidate is assessed performing the acquired and developed skills of Gymnastics.

The focus of the tasks will be:

1. Vaults
2. An agility sequence

1. Vaults.

- Through vault
- Straddle vault
- Handspring on
- $\frac{1}{2}$ on $\frac{1}{2}$ off.

Vaults will be assessed using the following movement phases:

- Shape and aesthetic quality
- Flight onto the box
- Flight off the box

- Repulsion
- Landing
- Overall efficiency

A supporter may stand in but that will result in the level of acquired and developed skills being reduced.

2. Agility sequence

An agility floor sequence containing two from each of the following movement categories:

- Rolls – forward (e.g. tuck, pike, straddle) backward (e.g. tuck, pike, straddle)
- Jumps – tuck, star, piked, straddle, half turn, full turn.
- Balances – shoulder, arabesque, lunge, headstand, handstand.
- Acrobatics – cartwheel, round off, handspring, backflip.
- Together with linking movements.

The gym square should be a minimum of 10m x 10m. A supporter may stand in but that will result in the level of acquired and developed skills being reduced.

The agility sequence will be assessed using the following movement phases:

Shape –

- aesthetic quality
- consistency
- control
- overall efficiency

Form –

- the quality of the individual elements of the sequence
- accuracy
- conformity to regulations.

Consistency –

- continuity/flow of the sequence
- aesthetic quality
- quality of the individual elements and of the overall sequence in relation to amplitude, timing and spatial awareness.

Control –

- Success in both the individual elements and the sequence as a whole.

These assessment criteria are used in conjunction with the generic assessment criteria for Gymnastic activities.

3. Ice (Figure) Skating

The candidate is assessed performing the acquired and developed skills of Ice(Figure) Skating.

The focus of the tasks will be:

A sequence incorporating ten elements from the three sections identified below with at least one from each section:

1. Step sequence

- Perimeter stroking forwards clockwise and counter-clockwise.
- Figure 8 backward crossovers, clockwise and counter clockwise
- Perimeter power crossover stroking
- Straight line step sequence.
- Forward drag

2. Spins and Spirals

- Upright or cross - toe spin
- Split spin
- Camel spin
- Forward spiral
- Backward spiral

3. Jumps

- Salchow
- Toe loop
- Flip
- Lutz
- Axel Paulsen
- Split-jump
- Loop/loop combination

The sequence will be assessed using the following movement phases:

Shape –

- aesthetic quality
- consistency
- control
- overall efficiency

Form –

- the quality of the individual elements of the sequence
- accuracy of the sequence
- sequence's conformity to regulations

Consistency –

- continuity/flow of the sequence
- aesthetic quality
- quality of the individual elements and the overall sequence in relation to amplitude, timing and spatial awareness

Control –

- Success in both the individual elements and the sequence as a whole.

These assessment criteria are used in conjunction with the generic assessment criteria for Gymnastic activities.

4. Rhythmic Gymnastics

The candidate is assessed performing the acquired and developed skills of Rhythmic Gymnastics.

The focus of the tasks will be:

Two ten movement floor agility sequences.

Sequence 1

Ten movements with at least one from each of:

- Leaps – split, fish, stag, cabriole, cossack, side
- Balances – passa, attitude, arabesque, side, front
- Pivots - passa, attitude, arabesque, fondu, high leg
- Flexibility skills - flexion, cobra, pull-up, illusion

Apparatus should be selected from – ribbon, hoop, ball, clubs and rope.

Sequence 2

Ten movements with at least one from each of:

- Rolls – forward(tuck, pike, straddle,), backward(tuck, pike, straddle)
- Jumps- tuck, star, piked, straddle, half turn, full turn
- Balances – shoulder, arabesque lunge, headstand, handstand
- Agilities – cartwheel, round off, handspring, backflip

The gym square should be a minimum of 10m x 10m. A supporter may stand in but that will result in the level of acquired and developed skills being reduced.

The agility sequence will be assessed using the following movement phases:

Shape –

- aesthetic quality
- consistency
- control
- overall efficiency

Form –

- the quality of the individual elements of the sequence
- accuracy of sequence
- sequence's conformity to regulations.

Consistency –

- continuity/flow of the sequence
- aesthetic quality,
- quality of the individual elements and the overall sequence in relation to amplitude, timing and spatial awareness.

Control –

- Success in both the individual elements and the sequence as a whole.

These assessment criteria are used in conjunction with the generic assessment criteria for Gymnastic activities.

5. Sports Acrobatics

The candidate is assessed performing the acquired and developed skills of Sports Acrobatics.

The focus of the tasks will be:

1. Tumbling

2. Floor work (pairs or trios)

1. Tumbling

Two runs each containing three moves

a) Straight run – round off and two flips

b) Board run – stretch jump from board, round off and flick.

2. Floor work

An agility sequence incorporating a minimum of the following elements:

- Three stationary balances (3-4 seconds)
- Three tempo moves (moves requiring support of another person)
- Three elements – front splits, tumbles, round off jump 1/2 turn, round off star jump, forward roll jump 1/2 turn.
- Three agility moves from – headstand, handstand, cartwheel, backflip, somersault.

- Linking movements should join the elements together.

The agility sequence will be assessed using the following movement phases:

Shape –

- aesthetic quality;
- consistency;
- control;
- overall efficiency.

Form –

- the quality of the individual elements of the sequence;
- accuracy of sequence;
- conformity of sequence to regulations.

Consistency –

- continuity/flow of the sequence;
- aesthetic quality;
- quality of the individual elements in relation to amplitude, timing and spatial awareness.

Control –

- success in both the individual elements and the sequence as a whole;
- strength of movement;
- co-ordination between fellow team members.

These assessment criteria are used in conjunction with the generic assessment criteria for Gymnastic activities.

6. Trampolining

The candidate is assessed performing the acquired and developed skills of Trampolining.

The focus of the tasks will be:

A ten contact routine.

The routine is:

1. Full twist jump
2. Straddle jump
3. Seat drop
4. Half twist to seat
5. Half twist to feet
6. Pike jump
7. Back drop
8. Half twist to feet
9. Tuck jump
10. Tucked front somersault

Candidates unable to perform a tucked front somersault may perform a half twist instead but this will result in the level of acquired and developed skills being reduced.

The routine will be assessed using the following movement phases:

Shape –

- aesthetic quality;
- consistency;
- control;
- overall efficiency.

Form –

- the quality of the individual elements of the sequence;
- sequence's accuracy as well as its conformity to regulations;
- height.

Consistency -

- Continuity/flow of the sequence

Control -

- Success in both the individual elements and the sequence as a whole;
- Centring;
- Phasing.

These assessment criteria are used in conjunction with the generic assessment criteria for Gymnastic activities.

3.9 Outdoor and Adventurous Activities

1. Canoeing (Ca)
2. Equestrian -X-Country (HRc)
3. Equestrian –Dressage (HRd)
4. Equestrian –Eventing (HRe)
5. Equestrian – Show Jumping (HRs)
6. Kayaking (Ka)
7. Mountain Biking (Mb)
8. Mountain walking (Mw)
9. Orienteering (Or)
10. Rock Climbing (Rc)
11. Sailing (Sa)
12. Skiing (Sk)
13. Snowboarding
14. Sub-Aqua Diving (SAD)
15. Surfing
16. Wakeboarding (Wb)
17. Wind surfing (Ws)

Outdoor and adventurous activities – Generic criteria

Performance

The candidate is assessed in:

The performance of a range of basic and advanced skills

The selection and application of appropriate solutions to the challenge

The understanding and application of risk assessment for the challenge and the conventions involved

The assessment should take place in authentic situations where tasks of appropriate pitch and challenge enable candidates to:

Demonstrate a range of basic and advanced skills

Demonstrate basic ability to plan for the challenge

Demonstrate an understanding and application of risk assessment for the challenge and the conventions involved

Be placed in rank order in terms of ability

The level of success of their basic and advanced skills will be based on the following evaluations:

Preparation and planning for all eventualities of the challenge

Efficient and accurate execution of the skills

Execution of a successful challenge completed in a safe and measured manner

Overall efficiency of performance demonstrating little wasted effort

The level of success of their planning awareness will be based on:

Accurate completion of the challenge

Safety and the avoidance of common difficulties in the challenge

Conservation practices/respect for others

Use and care of equipment

Planning for the minimisation of risk

These levels of success are used in conjunction with the following assessment criteria for the tasks of appropriate pitch and challenge in authentic contexts.

Band 1 (25-30)

The candidate demonstrates a very high level of acquired and developed skills that show a consistently high standard of accuracy, control and fluency under challenge.

There is consistent successful selection and application of a wide range of advanced techniques which, under the challenge maintain their accuracy, fluency and control.

A wide range of appropriate planning approaches are successfully and consistently used by the candidate demonstrating an excellent understanding of the demands of the challenge.

The overall performance in the challenge situation is excellent and indicative of high levels of learning and understanding.

The candidate demonstrates excellent physical and mental fitness.

The candidate demonstrates an excellent understanding and application of the conventions of the activity.

Band 2 (19 –24)

The candidate demonstrates a high level of acquired and developed skills that show a consistently high standard of accuracy, control and fluency under challenge.

There is consistent successful selection and application of a range of advanced techniques which, under the challenge maintain their accuracy, fluency and control.

A range of appropriate planning approaches are successfully and consistently used by the candidate demonstrating a good understanding of the demands of the challenge.

The overall performance in the challenge situation is very good and indicative of good levels of learning and understanding.

The candidate demonstrates good physical and mental fitness.

The candidate demonstrates a good understanding and application conventions of the activity.

Band 3 (13-18)

The candidate demonstrates a sound level of acquired and developed skills that show a consistently good standard of accuracy, control and fluency under challenge.

There is successful selection and application of a range of advanced techniques which, under the challenge maintain their accuracy, fluency and control.

A range of appropriate planning approaches are successfully used by the candidate demonstrating a sound understanding of the demands of the challenge.

The overall performance in the challenge is good and indicative of sound levels of learning and understanding.

The candidate demonstrates sound physical and mental fitness.

The candidate demonstrates a sound understanding and application of the conventions of the activity.

Band 4 (7-12)

The candidate demonstrates a limited level of acquired and developed skills that show some accuracy, control and fluency under challenge.

There is successful selection and application of advanced techniques which, under the challenge usually maintain some accuracy, fluency and control.

Some appropriate planning approaches are successfully used by the candidate demonstrating a limited understanding of the demands of the challenge.

The overall performance in the challenge is limited, inconsistent and indicative of limited learning and understanding.

The candidate demonstrates limited physical and mental fitness.

The candidate demonstrates limited understanding and application of the conventions of the activity.

Band 5 (0-6)

The candidate demonstrates a poor level of acquired and developed skills that show little accuracy, control and fluency under challenge.

There is an attempt to select and apply advanced techniques which, under the challenge maintain little accuracy, fluency and control.

Appropriate planning approaches are rarely used by the candidate demonstrating a poor understanding of the demands of the challenge.

The overall performance in the challenge is poor and indicative of some limited learning and understanding

The candidate demonstrates poor levels of physical and mental fitness.

The candidate demonstrates little understanding and application of the conventions of the activity.

1. Canoeing

The candidate is assessed performing the acquired and developed skills of canoeing

The focus of the tasks and challenge will include:

- Forward/reverse paddling
- Stopping
- Sweep and reverse sweep
- Draw strokes
- Support strokes
- High and low brace
- Ferry glide
- Rolls
- Capsize drills
- Rafting up
- Organisation and use of equipment
- Application of safety principles
- Conservation practices and respect for others.
- Navigation using maps/guides. Planning the route
- Organisation and use of equipment.

These assessment phases are used in conjunction with the generic assessment criteria for Outdoor and Adventurous activities.

2. Equestrian – Cross Country

The candidate is assessed performing the acquired and developed skills of Horse riding - Cross Country.

The following regulations will apply:

- Rules and guidelines will be followed as laid down by the British Horse Riding Society.
- Appropriate safety procedures must be applied.
- The candidate must maintain a log which covers both the planning of the course and performance of the course. The log **must** be available at moderation.

The log should contain:

- details of personal equipment for the course and the reasons for using it;
- details of the horse's equipment and the reasons for its use;
- discussion of safety principles to be applied;
- identification of the code of ethics to be followed;
- detailed course planning together with relevant safety measures;
- evaluative comments in relation to the course;

Horse Riding Course

The course should include 18 jumps of various difficulties measuring 2' 9". Each candidate and the horse must have appropriate safety equipment. During the course the candidate will be expected to exhibit an understanding of the spirit and contents of the riding code.

Assessment

Assessment is based on performance in a riding conditioned competitive situation where the candidates perform the acquired and developed skills under pressure in a strategic situation.

The level of success of the acquired and developed skill is measured through the phases identified below:

- Hand and leg position
- Body position/seat/posture
- Skill action/balance/timing
- Control/recovery/correction
- Effectiveness/accuracy
- Organisational use of equipment
- Application of safety principles
- Respect for horse and others.

These assessment phases are used in conjunction with the generic assessment criteria for Outdoor and Adventurous activities.

3. Equestrian – Dressage

The candidate is assessed performing the acquired and developed skills of Horse riding – Dressage.

The following regulations will apply:

- Rules and guidelines will be followed as laid down by the British Horse Riding Society.
- Appropriate safety procedures must be applied.
- The candidate must maintain a log which covers both the planning of the test and performance of the test. The log must be available at moderation.

The log should contain:

- Details of personal equipment for the test and the reasons for using it.
- Details of the horse's equipment and the reasons for its use.
- Discussion of safety principles to be applied.
- Identification of the code of ethics to be followed.
- Detailed test planning together with relevant safety measures.
- Evaluative comments in relation to the test.

Horse Riding Test

Each candidate and the horse must have appropriate safety equipment. During the test the candidate will be expected to exhibit an understanding of the spirit and contents of the riding code. The candidate should learn dressage test. The ACCA should be of relevant size.

Assessment

The level of success of the acquired and developed skill is measured through the phases identified below:

- Hand and leg position
- Body position/seat/posture
- Skill action/balance/timing
- Control/recovery/correction
- Effectiveness/accuracy
- Organisational use of equipment
- Application of safety principles
- Respect for horse and others.

These assessment phases are used in conjunction with the generic assessment criteria for Outdoor and Adventurous activities.

4. Equestrian – Eventing

The candidate is assessed performing the acquired and developed skills of Horse riding – Eventing. The following regulations will apply:

- Rules and guidelines will be followed as laid down by the British Eventing.
- Appropriate safety procedures must be applied.
- The candidate must maintain a log which covers both the planning of the two courses and the dressage test and the candidate's performance in all three sections. The log must be available at moderation.

The log should contain:

- Details of personal equipment for the test and the reasons for using it.
- Details of the horse's equipment and the reasons for its use.
- Discussion of safety principles to be applied.
- Identification of the code of ethics to be followed.
- Detailed test planning together with relevant safety measures.
- Evaluative comments in relation to the test.
- The level of the dressage test should be a British Eventing Intro Dressage test e.g. 100,101 or 102.
- The show jumping course should include 8-10 jumps (efforts) of various difficulties measuring 3ft. (0.914 metres)
- The cross country should include 10-18 jumps (efforts) of various difficulties measuring 2ft. 9ins. (0.84 metres)

Assessment

The level of success of the acquired and developed skill is measured through the phases identified below:

1.
 - Demonstration of appropriate techniques whilst performing a dressage test, riding a show jumping course and cross country course.
 - Hand and leg position
 - Body position/seat/posture.
 - Skill/action/balance/timing
 - Control/recovery/correction
 - Effectiveness/accuracy

2.
 - Safe preparation and use of equipment
 - Appropriate walking and planning of cross country course
 - Tactful riding throughout responding to the confidence and attitude of the horse.

3.
 - Application of safety principles
 - Respect for horse and others.-
 - knowledge of health and condition of horse
 - During the event the candidate will be expected to exhibit an understanding of the spirit and contents of the riding code.

These assessment phases are used in conjunction with the generic assessment criteria for Outdoor and Adventurous activities.

5. Equestrian – Show Jumping

The candidate is assessed performing the acquired and developed skills of Horse riding - Show Jumping.

The following regulations will apply:

- Rules and guidelines will be followed as laid down by the British Horse Riding Society.
- Appropriate safety procedures must be applied.
- The candidate must maintain a log, which covers both the planning of the course and performance of the course. The log **must** be available at moderation.

The log should contain:

- Details of personal equipment for the course and the reasons for using it.
- Details of the horse's equipment and the reasons for its use.
- Discussion of safety principles to be applied.
- Identification of the code of ethics to be followed.
- Detailed course planning together with relevant safety measures.
- Evaluative comments in relation to the course.

Horse Riding Course

The course should include 10 jumps of various difficulties measuring 3' 6". Each candidate and the horse must have appropriate safety equipment. During the course the candidate will be expected to exhibit an understanding of the spirit and contents of the riding code.

The level of success of the acquired and developed skill is measured through the phases identified below:

- Hand and leg position
- Body position/seat/posture
- Skill action/balance/timing
- Control/recovery/correction
- Effectiveness/accuracy
- Organisational use of equipment
- Application of safety principles
- Respect for horse and others

These assessment phases are used in conjunction with the generic assessment criteria for Outdoor and Adventurous activities.

6. Kayaking

The candidate is assessed performing the acquired and developed skills of Kayaking.

The focus of the tasks will be on **one** the following event areas:

- sprint;
- marathon;
- slalom;
- freestyle.

The requirements of weight and size of kayaks should be taken into account.

The level of success of the acquired and developed skill is measured through the movement phases identified below:

Sprint Events

- Paddling technique
- Back action
- Shoulder action
- Arm action

- Hip and leg action
- Body rotation
- Starting technique
- Finishing technique
- Boat control

Marathon Events

- Starting position and technique
- Assessing the conditions
- Paddling technique
- Wash hanging
- Portaging

Slalom

Paddling technique

- Forward power strokes
- Reverse power strokes
- Forward sweep strokes
- Reverse sweep/Pivot stroke
- Draw stroke
- Bow rudder(left and right)
- Bow draw(left and right)

In the following manoeuvres:

- Break-in
- Break-out
- Ferry glide
- Backing off
- Stagger
- 'S' upstream
- Merano

Freestyle

Paddling techniques

- Back action
- Shoulder action
- Arm action
- Hip and leg action
- Body action

Safe and controlled white water paddling strategy

Rolling

Basic freestyle moves

- Edge control and balance
- Surf front and back
- Spins
- Vertical enders
- Stern dips
- Double pump
- Cartwheel

Candidates should compete in these events in one of the following: K1, K2, K4, C1, C2, Freestyle kayak.

In addition to the above skills candidates should demonstrate a clear understanding of the equipment which is necessary for kayaking through its preparation for use. The equipment is as follows:

Kayak

How to set up a kayak

Dimensions

Weight

Paddles

How the length of the paddles should relate to each individual

How the size of the blade varies for different people

These assessment phases are used in conjunction with the generic assessment criteria for Outdoor and Adventurous activities.

7. Mountain Biking

The candidate is assessed performing the acquired and developed skills of Mountain Biking.

The focus of the tasks and challenge will include:

The route should be unfamiliar to the candidate and include various levels of off-road difficulty or gradients. The challenge should include 3 hours of cycling. The group size should be a minimum of 3 and a maximum of 5. Each candidate must wear appropriate clothing and the bike must be in a top technical condition. During the challenge the candidate will be expected to exhibit an understanding of the spirit and contents of the country code as it applies to mountain biking.

- The range and quality of the candidates biking skills; - i.e. Up-hill/Down-hill technique, gearing, control over a range of terrain.
- Navigation using maps/guides.
- Planning the route and the appropriate selection of the need for carrying.
- Organisation and the use of equipment.
- Application of safety principles, conservation practices and respect for others.

The following regulations will apply:

- Appropriate safety procedures must be applied.
- The candidate maintains a log which covers both the planning of the expedition and the expedition itself. The log must be available at moderation.

The log should contain:

- Details of personal equipment for the expedition and the reasons for taking it.
- Details of group equipment and the reasons for taking it.
- Discussion of the safety principles to be applied.
- Identification of the code of ethics to be followed.
- Detailed route planning together with relevant safety measures.
- Route card.
- Details of nutritional planning.
- Evaluative comments in relation to the expedition.

These assessment phases are used in conjunction with the generic assessment criteria for Outdoor and Adventurous activities.

8. Mountain walking

The candidate is assessed performing the acquired and developed skills of Mountain Walking.

The focus of the tasks and challenge will include:

- A two day journey with an overnight camp. A minimum of 14 hours walking with a minimum of 36kms.covered. The journey should take place in unfamiliar rural or open countryside with the use of minor roads or byways limited to that which is necessary to move between areas of open country. The journey should be sufficiently removed from habitation to ensure that the group is self-sufficient and dependent on its own resources. The accommodation will be by camping.

Candidates will keep a log which details their knowledge and application of all the following areas:

Route planning – to include distance covered, height gained, time taken for each leg, application of Naismith’s rule, compass bearings, and grid references;

Menu planning – including appropriate energy intake, palatability, ease of carrying;

Camp-craft – including efficiency of pitching tents and breaking camp, application of safe cooking practices, cleaning and hygiene. Choice of camp – grounds;

Accurate navigation using maps and compasses, including - setting the map using land features and compasses where appropriate, using ground features and landmarks to navigate;

Accurate use of pre-planned route card with map and compass, to monitor progress and to ensure the accuracy of the journey;

Efficient and logical packing of rucksacks for ease of access and safety;

Understanding of the need for emergency procedures and application of them if required;

Successful application of First Aid if appropriate;

Walking skills – maintaining walking speed and group integrity;

Co-operation, teamwork empathy and understanding within the walking group including fair and even distribution of tasks, including leading, and kit throughout the group;

Knowledge of access arrangements, land ownership and laws pertaining to the right to roam;

Application of the Countryside code and the conventions associated with it.

These assessment phases are used in conjunction with the generic assessment criteria for Outdoor and Adventurous activities.

Suitable venues for expeditions can be found in the following areas:

Dartmoor	Cheviots
Brecon Beacons	Highlands of Scotland
Black Mountains	Skye
Mid and North Wales Mountains	Harris
Peak District and Northern Moors	Lewis
Pennines	Arran
North Yorkshire Moors	Sperrin Mountains
Galloway Hills	Antrim Hills
Mountain of Mourne	Lake District

The type and amount of food to be taken forms part of the planning and this will be influenced by expected length of expedition, weight to be carried, personal preferences, energy and nutritional demands, emergency provisions.

The group size should be a minimum of 3 and a maximum of 6. Due account should be taken of seasonal conditions and, unless candidates have had considerable experience of high level summit ridges, these should be avoided. Expeditions should **not** take place in winter conditions. During the expedition the candidate will be expected to exhibit an understanding of the spirit and content of both the country and mountain codes.

It is expected that the planning of the route will involve identifying checkpoints and timings thereby enabling the teacher to supervise the candidates.

The candidate will maintain a detailed log which covers both the planning of the expedition and the expedition itself. The log **must** be available at moderation.

9. Orienteering

The candidate is assessed performing the acquired and developed skills of Orienteering.

The focus of the tasks and challenge will include:

The candidate will take part in a physically and demanding orienteering course – visiting a designated number of control sites in a prescribed order.

The following regulations apply:

- The appropriate safety measures must be applied.
- The candidate maintains a logbook which covers both the planning, training and preparation for the event itself. The logbook must be available at moderation.

The log should contain:

- Details of the type of training.
- Details of personal equipment necessary and reasons for taking it.
- Discussion of safety principles to be applied.
- Details and process of route planning.
- Evaluative comments.

Assessment

Assessment is based on performance in a competitive situation where the candidate performs the acquired and developed skills under pressure. The level of success of the acquired and developed skills is measured through the phases identified below.

- Use and interpretation of maps and their symbols.
- Navigation across country, following route using map and compass – obtaining bearings.
- Planning the route.
- Calculation of distances.
- Organisation and use of equipment, application of safety principles.

These assessment phases are used in conjunction with the generic assessment criteria for Outdoor and Adventurous activities.

10. Rock Climbing

The candidate is assessed performing the acquired and developed skills of Rock Climbing.

The focus of the tasks and challenge will include:

- Jamming
- Bridging
- Layback
- Fingerlocks
- Balanced footwork
- Slab climbing
- Correct use of harness
- Correct tying on using figure of 8 and bowline
- Correct use of belay plate
- Setting up of safe belays
- Base protection.
- Use of rope – bottom and top
- Abseiling
- Assessment and interpretation of weather information

Candidates should be working at HS level and towards HVS/5A/5B

Advanced skills

- Lead climbing commencing at V Diff.

The level of success of the acquired and developed skill is measured through the phases identified below:

- Demonstration of appropriate techniques whilst performing a range of skills which suit the challenges of the route;
- Route finding using guide books;
- Safe preparation of equipment – harness checks, maintenance and regular checking of gear racks, ropes, helmets, etc;
- Organisation and use of equipment;
- Application of safety principles, conservation practices and respect for others.

These assessment phases are used in conjunction with the generic assessment criteria for Outdoor and Adventurous activities.

The following regulations will apply:

- Appropriate safety procedures must be applied;
- The candidate maintains a log which covers both the planning of the challenge and the challenge itself. The log **must** be available at moderation.

The log should contain:

- Details of personal equipment and the reasons for taking it;
- Details of group equipment and reasons for taking it;
- Discussion of the safety principles to be applied;
- Identification of the code of ethics to be followed;
- Detailed planning of the route(s) to be followed with good use of guide books;
- Details of nutritional planning;
- Evaluative comments in relation to the days climbing.

When planning the challenge, due account should be taken of seasonal conditions and unless candidates have considerable experience of multi-pitch climbing then the climbs undertaken should be a single pitch. Challenges should **not** take place in winter conditions. During the challenge the candidate will be expected to exhibit an understanding of the spirit and content of both the country and mountain codes.

11. Sailing

The candidate is assessed performing the acquired and developed skills of Sailing.

The focus of the tasks and challenge will include:

- Rigging a boat
- Handling a boat ashore
- Rope work
- Crewing and helming
- Steering a course – tacking, reaching, running.
- Stopping, going about, gibing, reefing
- Leaving/returning to windward and leeward shores.
- Capsize drills/recovery
- Mark rounding

These skills will be demonstrated by the candidate being able to correctly rig a dingy or day boat in preparation for sailing. The candidate should reef ashore, launch and complete a course consisting of a minimum of 10 turns both up wind and down wind.

The following regulations will apply:

- Appropriate safety procedures must be applied.
- The candidate maintains a log which covers both the planning of the challenge and the challenge itself. The log **must** be available at moderation.

The log should contain:

- Details of personal equipment and the reasons for taking it.
- Details of group equipment and reasons for taking it.
- Discussion of the safety principles to be applied.
- Identification of the code of ethics to be followed..
- Details of nutritional planning.
- Evaluative comments in relation to the sailing.

These assessment phases are used in conjunction with the generic assessment criteria for Outdoor and Adventurous activities.

12. Skiing

The candidate is assessed performing the acquired and developed skills of Skiing.

The focus of the tasks and challenge will include:

- Gliding snowplough
- Snowplough turns
- Basic swing turns
- Parallel turns
- Skid to halt
- Step turns

The level of success of the acquired and developed skill is measured through the phases identified below:

- Ski placement
- Pole placement
- Body posture/balance
- Control
- Overall efficiency

Candidates are assessed in their ability to demonstrate their acquired and developed skills whilst completing a slalom course with a minimum of 15 turning poles or a free expression run of a minimum of 200 metres. This should be on a red run.

The following regulations will apply:

- Appropriate safety procedures must be applied.
- The candidate maintains a log which covers both the planning of the challenge and the challenge itself. The log **must** be available at moderation.

The log should contain:

- Details of personal equipment and the reasons for taking it.
- Details of group equipment and the reasons for taking it.
- Discussion of the safety principles to be applied.
- Identification of the code of ethics to be followed..
- Details of nutritional planning.
- Evaluative comments in relation to the skiing.

These assessment phases are used in conjunction with the generic assessment criteria for Outdoor and Adventurous activities.

13. Snowboarding

The candidate is assessed performing the acquired and developed skills of Snowboarding.

The focus of the tasks and challenge will include:

- Front and back side sliding
- Toe carving
- Heel carving
- Carved turns
- Swing to the heel from steep traverse
- Linked turns

Candidates are assessed in their ability to demonstrate their acquired and developed skills whilst completing a slalom course with a minimum of 15 turning poles or a free expression run of a minimum of 200 metres. This should be on a red run.

The following regulations will apply:

- Appropriate safety procedures must be applied;
- The candidate maintains a log which covers both the planning of the challenge and the challenge itself. The log **must** be available at moderation.

The log should contain:

- Details of personal equipment and the reasons for taking it;
- Details of group equipment and the reasons for taking it;
- Discussion of the safety principles to be applied;
- Identification of the code of ethics to be followed;
- Details of nutritional planning;
- Evaluative comments in relation to the snowboarding.

These assessment phases are used in conjunction with the generic assessment criteria for Outdoor and Adventurous activities.

14. Sub Aqua diving

The candidate is assessed performing the acquired and developed skills of Sub-Aqua diving.

The focus of the tasks and challenge will include:

- Organisation and use of equipment;
- Demonstration of appropriate safety procedures – safe entry into water, buoyancy control, safe method of descent, cleaning of mask and mouthpiece, removal of scuba equipment when safely on surface;
- Achievement of neutral buoyancy with weight belt correctly weighted;
- Correct use of buoyancy compensator;
- Correct use of alternative air supply;
- Planning the dive with particular attention to – air consumption, decompression, tides and currents, weather seastate, entry and exit, buddy check, signals, lost buddy procedure, dive plan;
- Application of understanding of the spirit and content of Diver's code.

Candidates are assessed in their ability to demonstrate their acquired and developed skills whilst completing:

- A minimum of two dives. (A maximum of two dives in any one day)
- Each dive should last a minimum of 15 minutes.
- Each dive should be a maximum of 18 metres.

The following regulations will apply:

- Appropriate safety procedures must be applied.
- The candidate must wear the appropriate equipment and, if present, the boat must carry the appropriate safety equipment;
- The candidate maintains a log which covers both the planning of the challenge and the challenge itself. The log must be available at moderation.

The log should contain:

- The date, time and location of each dive;
- The depth, duration and Open Water Instructor(s);
- The planning and safety measure involved together with the use of Buhlmann Tables for the appropriate depth;
- Weather and water conditions encountered;
- Details of personal equipment and the reasons for taking it;
- Details of group equipment and the reasons for taking it;
- Discussion of the safety principles to be applied;
- Identification of the code of ethics to be followed;
- Details of nutritional planning;
- Evaluative comments in relation to the diving.

These assessment phases are used in conjunction with the generic assessment criteria for Outdoor and Adventurous activities.

15. SURFING

The candidate is assessed performing the acquired and developed skills of surfing.

The focus of the tasks and challenge will be:

Organisation and use of equipment.

Effective paddling

Duck diving/rolling the board

Effective pop up/take off

Cutbacks

Floater

Hacks

Snaps

Re-entries

Wave selection

Positioning in the water

Surfing forehand and backhand waves

The level of success of the acquired and developed skills is measured through the phases identified below:

Control and completion of manoeuvres
Length of ride
Commitment, speed and power when completing turns
Surfing in the most critical sections of the wave.
Organisation and use of equipment

Candidates will be assessed in their ability to demonstrate the acquired and developed skills whilst completing a minimum of 15 surfs in both forehand and backhand waves in a variety of conditions.

The following regulations will apply:

Appropriate safety measures must be applied.
Candidates must apply local knowledge of where to surf in relation to wind and swell conditions.

The candidate maintains a log which covers both the planning of the challenge and the challenge itself. The log **must** be available at moderation.

The log should contain:

Details and pictures of personal equipment and the reasons for taking it. This should include an explanation of their quiver of boards and the conditions which suit particular boards.

Identification of local breaks surfed and best times/conditions to surf each break.

Detailed knowledge of Health and safety principles including: coping with rips and currents, distress signals, lifeguard flags.

Identification of the surfing code of ethics.(eg right of way, snaking, avoiding collisions)

Details of nutritional planning.

Recorded details of 15 surfs to include: dates, time of day, conditions (wind strength and direction, swell size) tides, selected board and the reason for selection (e.g. 6'0x19x3 fish due to small mushy waves, 6'6x18.5x2.5 rounded pin short board for 4ft-5ft clean surf)

Evaluative comments in relation to each of the 15 personal surf performances and conditions experienced.

If available photos of candidate surfing

If appropriate results of positions in BSA competitions.

These assessment criteria are used in conjunction with the generic assessment criteria for Outdoor and Adventurous activities.

16. Wakeboarding

The candidate is assessed performing the acquired and developed skills of Wakeboarding.

The focus of the tasks and challenge will include:

- Deep water strat
- Cuts
- Jumps spins,
- Grabs
- Falling
- Organisation and use of equipment
- Health and safety (including distress signals)
- Application and understanding of the spirit and content of the ethics of wakeboarding.

The following regulations will apply:

- Appropriate safety procedures must be applied;
- The rules and guidelines of the UK Wakeboarding Association will be followed;
- A cable may be used;
- The candidate must wear the appropriate equipment and, if present, the boat must carry the appropriate safety equipment;
- The candidate maintains a log which covers both the planning of the challenge and the challenge itself;
- The log **must** be available at moderation.

The log should contain:

- Planning for a single pass with relevant safety measures;
- Details of the tricks performed;
- Details of personal equipment and the reasons for using it;
- Details of safety prior to the activity including details of the cable low lines;
- Discussion of safety principles to be applied;
- Identification of the code of ethics to be applied;
- Details of nutritional planning;
- Evaluative comments in relation to the wakeboarding.

These assessment phases are used in conjunction with the generic assessment criteria for Outdoor and Adventurous activities.

The following are given as suggestions/exemplars of conditioned competitive situations and are not seen as being prescriptive. Centres may devise their own conditioned competitive situations.

Building Blocks and Basic Tricks

Building Blocks	Additional moves	Additional moves	New trick made
Wake jump	+ grab	+ 180	Grab 180
Backroll	+ grab	+ 180	Grabbed backroll

			to fakie
Tantrum	+ grab	+ 180	Grabbed tantrum/ tantrum to fakie
Front roll	+ grab	+ 180	Grabbed front roll/Grabbed scarecrow
Toe side roll	+ grab	+ 180	Toe side grabbed backroll to fakie
Raley	+ grab	+ 180	Hoochie glide/OHH of Krypt (Raley to fakie)
Wake jump	+ 180	+ 180	360

Terminology Explained

Grab: A grab is where you grasp the board and hold it for about a second, but the longer the better. There are many different types of grab; they are determined by the part of the board which is being grabbed e.g. if you grab the back of the board this is called a 'tail grab' as opposed to a 'nose grab' at the front end.

Any **invert** (flip) with an added 180 is called a 'fakie'.

17. Windsurfing

The candidate is assessed performing the acquired and developed skills of Windsurfing.

The focus of the tasks and challenge will include:

- Organisation and use of equipment
- Rigging the board
- Canoeing/landing
- Tacking
- Gibing
- Going about
- Capsizing
- Application of knowledge of where to sail
- Knowledge of health and safety(including distress signals)
- Application of the spirit and content of the ethics of sailing/windsurfing.

Candidates are assessed in their ability to demonstrate their acquired and developed skills whilst completing:

The following regulations will apply: A set course on water in a competitive event in which they perform a minimum of ten tactical moves both upwind and downwind.

- Appropriate safety procedures must be applied;
- The candidate must wear the appropriate equipment and the boat must carry the appropriate safety equipment;
- The candidate maintains a log which covers both the planning of the challenge and the challenge itself;
- The log **must** be available at moderation.

The log should contain

- Details of personal equipment and the reasons for using it;
- Details of the group equipment and the reasons for taking it;
- Details of safety prior to the activity;
- Discussion of safety principles to be applied;
- Identification of the code of ethics to be applied;
- Details of nutritional planning;
- Evaluative comments in relation to the Windsurfing.

These assessment phases are used in conjunction with the generic assessment criteria for Outdoor and Adventurous activities

3.10 Swimming Activities

1. Competitive Swimming (Sw)
2. Life Saving (Ls)

Swimming activities – Generic criteria

Performance

The candidate is assessed in:

The performance of a range of basic and advanced skills.

The selection and application of skills and tactics.

The understanding and application of rules.

The assessment should take place in conditioned competitive situations where tasks of appropriate pitch and challenge enable candidates to:

Demonstrate a range of basic and advanced skills.

Demonstrate appropriate tactical awareness.

Demonstrate an understanding and application of rules.

Be placed in rank order in terms of ability.

The level of success of their basic and advanced skills will be based on the accurate replication of actions, phases and sequences

The level of success in appropriate tactical awareness will be based on:

- Performance at maximum levels.

These assessment phases are used in conjunction with the following assessment criteria for the tasks of appropriate pitch and challenge in authentic contexts.

Band 1 (25-30)

The candidate demonstrates a very high level of acquired and developed skills that show a consistently high standard of accuracy, control and fluency under competitive pressure.

There is consistent successful selection and application of a wide range of advanced techniques which, under competitive pressure maintain their accuracy, fluency and control.

A wide range of appropriate strategies and tactics are successfully and consistently used by the candidate demonstrating an excellent understanding of the perceptual requirements of the activity.

The overall performance in the competitive situation is excellent and indicative of high levels of learning and understanding.

The candidate demonstrates excellent physical and mental fitness.

The candidate demonstrates an excellent understanding and application of the rules/regulations of the activity.

Band 2 (19-24)

The candidate demonstrates a high level of acquired and developed skills that show a consistently high standard of accuracy, control and fluency under competitive pressure.

There is consistent successful selection and application of a range of advanced techniques which, under competitive pressure maintain their accuracy, fluency and control.

A range of appropriate strategies and tactics are successfully and consistently used by the candidate demonstrating a good understanding of the perceptual requirements of the activity.

The overall performance in the competitive situation is very good and indicative of good levels of learning and understanding.

The candidate demonstrates good physical and mental fitness.

The candidate demonstrates a good understanding and application of the rules/regulations of the activity.

Band 3 (13-18)

The candidate demonstrates a sound level of acquired and developed skills that show a consistently good standard of accuracy, control and fluency under competitive pressure.

There is successful selection and application of a range of advanced techniques which, under competitive pressure maintain their accuracy, fluency and control.

A limited range of appropriate strategies and tactics are successfully used by the candidate demonstrating a sound understanding of the perceptual requirements of the activity.

The overall performance in the competitive situation is good and indicative of sound levels of learning and understanding.

The candidate demonstrates sound physical and mental fitness.

The candidate demonstrates a sound understanding and application of the rules/regulations of the activity.

Band 4 (7-12)

The candidate demonstrates a limited level of acquired and developed skills that show some accuracy, control and fluency under competitive pressure.

There is successful selection and application of advanced techniques which, under competitive pressure usually maintain some accuracy, fluency and control.

Some appropriate strategies and tactics are successfully used by the candidate demonstrating a limited understanding of the perceptual requirements of the activity.

The overall performance in the competitive situation is limited, inconsistent and indicative of limited learning and understanding.

The candidate demonstrates limited physical and mental fitness.

The candidate demonstrates limited understanding and application of the rules/regulations of the activity.

Band 5 (0-6)

The candidate demonstrates a poor level of acquired and developed skills that show little accuracy, control and fluency under competitive pressure.

There is an attempt to select and apply advanced techniques which, under competitive pressure maintain little accuracy, fluency and control.

Appropriate strategies and tactics are rarely used by the candidate demonstrating a poor understanding of the perceptual requirements of the activity.

The overall performance in the competitive situation is poor, inconsistent and indicative of limited learning and understanding

The candidate demonstrates inadequate levels of physical and mental fitness.

The candidate demonstrates little understanding and application of the rules/regulations of the activity.

1. Competitive Swimming

The candidate is assessed performing the acquired and developed skills of Competitive Swimming.

The candidate is assessed in two acquired and developed skills, these being selected from the following:

- front crawl,
- back stroke,
- breast stroke,
- butterfly.

The focus of the tasks will include:

- Racing starts
- Racing turns
- Full strokes
- Finishes

The level of success of the acquired and developed skill is measured through the movement phases identified below:

- Body position
- Leg action
- Arm action
- Breathing
- Timing/Overall efficiency

These assessment phases are used in conjunction with the generic assessment criteria for Swimming activities.

2. Life saving

The candidate is assessed performing the acquired and developed skills of Life Saving.

The focus of the tasks will include:

1. Cardio-pulmonary Resuscitation(CPR)
 - Perform emergency resuscitation on a casualty who is not breathing and shows no sign of circulation.
 - Demonstrate competence in the techniques for:
turning a face down casualty to a face up position;
determining signs of circulation in adults, young children and babies;
managing a casualty who is vomiting;
placing a casualty in the recovery position;
 - Demonstrate competence in the application of single CPR on a range of approved manikins.

2. Water rescue skills :

- Practical rescue – immediate response. Demonstrate a rescue using the principles of reaching, throwing or wading during a simulated incident;
- Contact rescue – deep water. Demonstrate a contact rescue of a casualty in deep water over a short distance (Minimum 5 metres);
- Deep water recovery (Minimum depth 1.5 metres) – demonstrate the rescue of a casualty who is lying on the bottom of the deepest part of the pool;
- Swim rescue – conscious casualty. Demonstrate personal fitness through performing the rapid rescue, over a distance of a conscious casualty who is in deep water (swim 20 metres, tow 20 metres);
- Swim rescue – unconscious casualty. Demonstrate personal fitness through performing a rapid rescue, over a distance of an unconscious casualty who is in deep water (swim 20 metres, tow 20 metres);

The level of success of the acquired and developed skill is measured through the movement phases identified below:

- Assessment of the situation
- Preparation for the rescue
- Recovery of the casualty
- Landing of the casualty
- Treatment of the casualty

These assessment phases are used in conjunction with the generic assessment criteria for Swimming activities.

3.11 Safe and effective exercise activities

Safe & Effective Exercise activities – Generic criteria.

Performance

The candidate is assessed in:

The performance of a range of basic and advanced skills.

The selection and application of skills and tactics

The understanding and application of rules.

The assessment should take place in conditioned competitive situations where tasks of appropriate pitch and challenge enable candidates to:

Demonstrate a range of basic and advanced skills

Demonstrate appropriate strategic awareness

Demonstrate an understanding and application of rules/health and safety implications

Be placed in rank order in terms of ability.

The level of success of their basic and advanced skills will be based on the following movement phases together with those appropriate to the activity:

- Form
- Consistency
- Control

The level of success in appropriate strategic awareness will be based on:

- Specificity
- Progression
- Overload
- Regression
- Tedium
- Adaptation

These assessment phases are used in conjunction with the following assessment criteria for the tasks of appropriate pitch and challenge in authentic contexts.

Band 1 (25-30)

The candidate demonstrates a very high level of acquired and developed skills that show a consistently high standard of accuracy, control and fluency under performance pressure.

There is consistent successful selection and application of a wide range of advanced techniques which, under performance pressure, maintain their accuracy, fluency and control.

A wide range of appropriate strategies and tactics are successfully and consistently used by the candidate demonstrating an excellent understanding of the perceptual requirements of the activity.

The overall standard in the performance situation is excellent and indicative of high levels of learning and understanding.

The candidate demonstrates excellent physical and mental fitness.

The candidate demonstrates an excellent understanding and application of the rules/regulations/conventions of the activity.

A comprehensive, detailed record of the candidate's participation in safe and effective exercise activities is in evidence.

Band 2 (19-24)

The candidate demonstrates a high level of acquired and developed skills that show a consistently high standard of accuracy, control and fluency under performance pressure.

There is consistent successful selection and application of a range of advanced techniques which, under performance pressure, maintain their accuracy, fluency and control.

A range of appropriate strategies and tactics are successfully and consistently used by the candidate demonstrating a good understanding of the perceptual requirements of the activity.

The overall standard in the performance situation is very good and indicative of good levels of learning and understanding.

The candidate demonstrates good physical and mental fitness.

The candidate demonstrates a good understanding and application of the rules/regulations/conventions of the activity.

An extensive, detailed record of the candidate's participation in safe and effective exercise activities is in evidence.

Band 3 (13-18)

The candidate demonstrates a sound level of acquired and developed skills that show a consistently good standard of accuracy, control and fluency under performance pressure.

There is successful selection and application of a range of advanced techniques which, under performance pressure, maintain their accuracy, fluency and control.

A limited range of appropriate strategies and tactics are successfully used by the candidate demonstrating a sound understanding of the perceptual requirements of the activity.

The overall standard in the performance situation is good and indicative of sound levels of learning and understanding.

The candidate demonstrates sound physical and mental fitness.

The candidate demonstrates a sound understanding and application of the rules/regulations/conventions of the activity.

A detailed record of the candidate's participation in safe and effective exercise activities is in evidence.

Band 4 (7-12)

The candidate demonstrates a limited level of acquired and developed skills that show some accuracy, control and fluency under performance pressure.

There is successful selection and application of advanced techniques which, under performance pressure, usually maintain some accuracy, fluency and control.

Some appropriate strategies and tactics are successfully used by the candidate demonstrating a limited understanding of the perceptual requirements of the activity.

The overall standard in the performance situation is limited, inconsistent and indicative of limited learning and understanding.

The candidate demonstrates limited physical and mental fitness.

The candidate demonstrates limited understanding and application of the rules/regulations/conventions of the activity.

A limited record of the candidate's participation in safe and effective exercise activities is in evidence.

Band 5 (0-6)

The candidate demonstrates a poor level of acquired and developed skills that show little accuracy, control and fluency under performance pressure.

There is an attempt to select and apply advanced techniques which, under performance pressure, maintain little accuracy, fluency and control.

Appropriate strategies and tactics are rarely used by the candidate demonstrating a poor understanding of the perceptual requirements of the activity.

The overall standard in the performance situation is poor, inconsistent and indicative of limited learning and understanding.

The candidate demonstrates inadequate levels of physical and mental fitness.

The candidate demonstrates little understanding and application of the rules/regulations/conventions of the activity.

There is little or no evidence of the candidate's participation in safe and effective exercise activities.

Circuit training

The focus of the tasks will be:

The design and implementation of **two** training programmes from:

- Body weight exercises
- Free weights and resistance machines
- Cardiovascular equipment

A body weight exercise programme should include a minimum of ten exercises with at least two from each of the following three areas. Equipment, such as a stability board, core board and wobble disc, may be used.

Upper body

- Press ups
- Pull ups/ chin ups
- Triceps dips

Core

- Sit ups/twisted sit ups
- Crunches/abdominal curls/oblique curls
- Back extension
- Knee raises

Lower body

- Static/dynamic lunges/reverse lunges
- Squats/lateral squats
- Standing kick backs/bent knee kick crosses
- Side lying leg lifts
- Standing calf raises
- Toe raises
- Tuck jumps
- Ski jumps
-

A resistance training programme should include a minimum of two exercises from each of the following areas:

Upper body

- Bench press/dumb-bell flies
- Overhead dumb-bell press/ lateral dumb-bell raises
- seated rows/ upright rows
- lateral pull down/ pec-deck flies
- Bent over rows/ dead lift
- Biceps curl
- Tricep press/tricep kick back/overhead tricep extension

Core

- Inclined sit ups
- Lateral pulley extensions
- Total abdominal crunches

Lower body

- Leg press
- Leg curls
- Leg extensions
- Barbell/ dumb-bell squats
- One leg bench squats
- Standing/seated calf raises
- Heel raises
- Standing cable pull

A cardiovascular equipment exercise programme should include a minimum of two different pieces of equipment for each of the following areas:

Upper body

- Rower
- Cross trainer
- Vertical climber

Core

- Rower
- Stepper
- Vertical climber

Lower body

- Static bike
- Treadmill
- Rower
- Stepper
- Cross trainer
- Stairmaster

A detailed log should be kept which includes:

- The goals of each exercise programme. (Muscle groups targeted, energy systems/muscle fibres targeted);
- Time scale;
- Identification and description of exercises involved;
- Design of programme – repetitions, sets, weight, rest intervals;
- Detailed description of personal warm up and cool down;
- Health and safety implications/risk assessments;
- Record of implementation with evaluative comments;
- Assessment and evaluation of goals;
- Authentication statement from a qualified instructor.

4 Coaching and Leading – Assessment criteria

The candidate is assessed in coaching/leading an activity from the eleven activity profiles. It MUST be a different activity from a different activity profile to the candidate's other assessed activity.

- The performance of a range of basic and advanced skills.
- The selection and application of skills and strategies.
- The understanding of rules/regulations/conventions.
- Technical knowledge

The assessment should take place in situations where tasks of appropriate pitch and challenge enable candidates to:

- Coach/lead safe, purposeful and enjoyable sessions;
- Demonstrate a range of basic and advanced acquired and developed skills in an authentic context;
- Demonstrate competence in organisational skills related to the planning and delivery of sessions;
- Demonstrate appropriate communication skills;
- Demonstrate an understanding and appreciation of health and safety procedures;
- Implement risk assessment procedures;
- Demonstrate a knowledge and understanding of the fitness and health aspects of the activity;
- Evaluate sessions delivered and plan for improvement;
- Demonstrate an awareness of Child Protection issues and procedures;
- Operate the principle of inclusion in their sessions.

Suitable situations could be generated by candidates working with primary school children in Top Sport/Dragon Sport sessions, lower secondary school pupils and youth groups. Candidates will be assessed in their ability to lead safe, purposeful and enjoyable activities whilst exhibiting motivation, responsibility, control and confidence. Candidates who participate in courses leading to the British Sports Trust's Community Sports Leader's Award or a Level Two Governing Body Coaching award will develop many of the skills and qualities required by the criteria. Candidates are **not required to hold these awards**.

The tasks generated should identify the candidate's level of autonomy whilst providing the range of pitch and challenge to enable ability differentials to be displayed.

The level of success of their basic and advanced skills together with their strategic awareness will be based on:

- Planning and organisation
- Delivery
- Evaluation and reflection
- Technical knowledge
- The production of a detailed log.

Planning and organisation

This will include: a scheme of work, individual session plans, identification of long and short term objectives, facility details, equipment details, participant information, and health and safety issues including risk assessments, warm up and cool down, child protection details.

Delivery

This will include: Appearance, presence and personality, communication, voice tone, demonstrations, control, positioning, motivation/praise, enthusiasm, positive relationship with participants, equal treatment of participants, inclusion, timekeeping.

Evaluation and reflection

This will include: identification of each performer's strengths and weaknesses during the session, identification of their own strengths and weaknesses in delivering the session, the strengths and weaknesses of the sessions.

Technical knowledge

This will include: knowledge of the correct technical models for the skills of the activity and the analytical phases, knowledge of progressive practices to develop skills, ability to demonstrate/explain technical models.

The production of a detailed log.

This will include;

- Records of their coaching/leading activities over a three month period;
- Include a scheme of work which identifies progression and has a minimum of ten hours of session plans together with appropriate evaluations of each of the sessions and risk assessments;
- Have a personal video record of a minimum of forty minutes of coaching/leading;
- Details of health and safety issues relevant to the activity;
- Details of child protection procedures in operation for the activity together with evidence of the candidate's CRB clearance;
- Evidence of the candidate's appropriate first aid qualification;
- Details of the fitness and health benefits of the activity.

These assessment phases will be used in conjunction with the following assessment criteria for the tasks of appropriate pitch and challenge in authentic contexts.

Band 1 (25-30)

- An excellent level of basic and advanced coaching/leadership skills is demonstrated.
- A wide range of appropriate strategies is successfully and consistently used by the candidate demonstrating an excellent understanding of the perceptual aspects of coaching/leading.
- The candidate demonstrates excellent awareness of health and safety issues.
- The candidate demonstrates excellent implementation of risk assessments.
- The candidate demonstrates excellent awareness of child protection issues.
- The candidate demonstrates excellent awareness of the fitness and health benefits of the activity.
- The overall performance in the coaching/leading is excellent and indicative of high levels of learning and understanding.
- Excellent organisational skills in planning and delivering sessions are demonstrated.
- The candidate demonstrates excellent knowledge and understanding of the rules, regulations/conventions of the activity.
- There are excellent evaluative/reflective skills in relation to sessions delivered.
- The possession of the British Sports Trust's Community Sports Leaders Award or a Governing Body Level Two Coaching/Leading qualification **may** be indicative of attainment at this standard but the assessment criteria must still be met

Band 2 (19-24)

- A high level of basic and advanced coaching/leadership skills is demonstrated.
- A range of appropriate strategies is successfully and consistently used by the candidate demonstrating a good understanding of the perceptual aspects of coaching/leading.
- The candidate demonstrates a high level of awareness of health and safety issues.
- The candidate demonstrates a very good implementation of risk assessments.
- The candidate demonstrates very good awareness of child protection issues.
- The candidate demonstrates very good awareness of the fitness and health benefits of the activity.
- The overall performance in the coaching/leading is very good and indicative of good levels of learning and understanding.
- Very good organisational skills in planning and delivering sessions are demonstrated.

- The candidate demonstrates very good knowledge and understanding of the rules, regulations/conventions of the activity.
- There are very good evaluative/reflective skills in relation to sessions delivered.
- The possession of the British Sports Trust's Community Sports Leaders Award or a Governing Body Level Two Coaching/Leading qualification may be indicative of attainment at this standard but the assessment criteria must still be met.

Band 3 (13-18)

- A sound level of basic and advanced coaching/leadership skills is demonstrated.
- A range of appropriate strategies is successfully and consistently used by the candidate demonstrating a sound understanding of the perceptual aspects of coaching/leading.
- The candidate demonstrates a sound awareness of health and safety issues.
- The candidate demonstrates sound implementation of risk assessments.
- The candidate demonstrates sound awareness of child protection issues.
- The candidate demonstrates sound awareness of the fitness and health benefits of the activity.
- The overall performance in the coaching/leading is sound and indicative of sound levels of learning and understanding.
- Sound organisational skills in planning and delivering sessions are demonstrated.
- The candidate demonstrates sound knowledge and understanding of the rules, regulations/conventions of the activity.
- There are sound evaluative/reflective skills in relation to sessions delivered.
- The possession of the British Sports Trust's Community Sports Leaders Award or a Governing Body Level Two Coaching/Leading qualification **may** be indicative of attainment at this standard but the assessment criteria must still be met

Band 4 (7-12)

- A limited level of basic and advanced coaching/leadership skills is demonstrated.
- Some appropriate strategies are successfully and consistently used by the candidate demonstrating a limited understanding of the perceptual aspects of coaching/leading.
- The candidate demonstrates limited awareness of health and safety issues.
- The candidate demonstrates limited implementation of risk assessments.

- The candidate demonstrates limited awareness of child protection issues.
- The candidate demonstrates limited awareness of the fitness and health benefits of the activity.
- The overall performance in the coaching/leading is limited, inconsistent and indicative of limited learning and understanding.
- Limited organisational skills in planning and delivering sessions are demonstrated.
- The candidate demonstrates limited knowledge and understanding of the rules, regulations/conventions of the activity.
- There are limited evaluative/reflective skills in relation to sessions delivered.
- The possession of the British Sports Trust's Community Sports Leaders Award or a Governing Body Level Two Coaching/Leading qualification **may** be indicative of attainment at this standard but the assessment criteria must still be met.

Band 5 (0-6)

- A poor level of basic and advanced coaching/leadership skills is demonstrated.
- Appropriate strategies are rarely used by the candidate demonstrating a poor understanding of the perceptual aspects of coaching/leading.
- The candidate demonstrates poor awareness of health and safety issues.
- The candidate demonstrates poor implementation of risk assessments.
- The candidate demonstrates poor awareness of child protection issues.
- The candidate demonstrates poor awareness of the fitness and health benefits of the activity.
- The overall performance in the coaching/leading is poor, inconsistent and indicative of limited levels of learning and understanding.
- Poor organisational skills in planning and delivering sessions are demonstrated.
- The candidate demonstrates little knowledge and understanding of the rules, regulations/conventions of the activity.
- There are poor evaluative/reflective skills in relation to sessions delivered.

5 Officiating – Assessment criteria.

The candidate is assessed in officiating an activity from the invasion game activity profile. It MUST be a different activity to the candidate's other assessed activity.

The candidate is assessed in one activity from:

ASSOCIATION FOOTBALL
BASKETBALL
FIELD HOCKEY
GAELIC FOOTBALL
HURLING
NETBALL
RUGBY LEAGUE
RUGBY UNION
HANDBALL
LACROSSE

The candidate is assessed in:

- The performance of a range of basic and advanced skills.
- The selection and application of skills and strategies.
- The understanding of rules/regulations/conventions.

The assessment should take place in situations where tasks of appropriate pitch and challenge enable candidates to:

- Officiate safe, purposeful and enjoyable sessions.
 - Demonstrate a range of basic and advanced acquired and developed skills in an authentic context;
 - Demonstrate competence in decision making skills related to the application of the rules/ regulations / conventions of the activity;
 - Demonstrate an understanding and appreciation of health and safety procedures;
 - Implement risk assessment procedures;
 - Demonstrate a knowledge and understanding of the fitness and health aspects of the activity;
 - Evaluate sessions officiated and plan for improvement;
 - Demonstrate an awareness of Child Protection issues.

Suitable situations could be generated by candidates working with primary school children in Top Sport/Dragon Sport sessions, lower secondary school pupils and youth groups. Candidates will be assessed in their ability to officiate in safe, purposeful and enjoyable activities whilst exhibiting responsibility, control and confidence. Candidates who participate in courses leading to a Level Two Governing Body Officiating award will develop many of the skills and qualities required by the criteria. Candidates do **not** need to hold this award.

The tasks generated should identify the candidate's level of autonomy whilst providing the range of pitch and challenge to enable ability differentials to be displayed.

The level of success of their basic and advanced skills together with their strategic awareness will be based on:

- Planning and organisation
- Officiating
- Evaluation and reflection
- Technical knowledge
- The production of a detailed log.

Planning and organisation

This will include: Knowledge of participants, knowledge of rules of competition, knowledge of venue/facility, risk assessments/health and safety, child protection, preparation of equipment.

Officiating

This will include: appearance, interaction with participants, managing participants, decision making, positioning, consistency, equity, fitness, team work with other officials – where appropriate.

Evaluation and reflection

This will include: identifying the strengths and weaknesses of their performance in terms of their planning and organisation, officiating and technical knowledge.

Technical knowledge

This will include: knowledge and application of the rules and regulations of the activity, candidate's appropriate level of fitness.

The production of a detailed log

This will include:

- Records of their officiating activities over a three month period;
- A minimum of four qualified assessor evaluations of the sessions officiated;
- Evidence of risk assessments undertaken;
- Have a personal video record of a minimum of forty minutes of officiating;
- Details of health and safety issues relevant to the activity;
- Details of child protection procedures in operation for the activity together with evidence of the candidate's CRB clearance;
- Details of the fitness and health benefits of the activity and of officiating the activity.

These assessment phases will be used in conjunction with the following assessment criteria for the tasks of appropriate pitch and challenge in authentic contexts.

Band 1 (25-30)

- An excellent level of basic and advanced officiating skills is demonstrated.
- A wide range of appropriate strategies is successfully and consistently used by the candidate demonstrating an excellent understanding of the perceptual aspects of officiating.
- The candidate demonstrates excellent awareness of health and safety issues.
- The candidate demonstrates excellent implementation of risk assessments.
- The candidate demonstrates excellent awareness of child protection issues.
- The candidate demonstrates excellent awareness of the fitness and health benefits of the activity.
- The overall performance in the officiating is excellent and indicative of high levels of learning and understanding.
- Excellent organisational skills in the preparation to officiate activity sessions are demonstrated.
- The candidate demonstrates excellent knowledge, understanding and consistent application of the rules, regulations/conventions of the activity.
- There are excellent evaluative and reflective skills in relation to sessions officiated.
- The possession of a Governing Body Level Two Officiating qualification (or equivalent) **may** be an indicator of attainment at this standard but the assessment criteria must still be met.

Band 2 (19-24)

- An high level of basic and advanced officiating skills is demonstrated.
- A range of appropriate strategies is successfully and consistently used by the candidate demonstrating a good understanding of the perceptual aspects of officiating.
- The candidate demonstrates a high level of awareness of health and safety issues.
- The candidate demonstrates a very good implementation of risk assessments.
- The candidate demonstrates very good awareness of child protection issues.
- The candidate demonstrates very good awareness of the fitness and health benefits of the activity.
- The overall performance in the officiating is very good and indicative of good levels of learning and understanding.
- Very good organisational skills in the preparation to officiate activity sessions are demonstrated.
- The candidate demonstrates very good knowledge, understanding and consistent application of the rules, regulations/conventions of the activity.
- There are very good evaluative and reflective skills in relation to sessions officiated.
- The possession of a Governing Body Level Two Officiating qualification (or equivalent) **may** be an indicator of attainment at this standard but the assessment criteria must still be met.

Band 3 (13-18)

- A sound level of basic and advanced officiating skills is demonstrated.
- A range of appropriate strategies is successfully and consistently used by the candidate demonstrating a sound understanding of the perceptual aspects of officiating.
- The candidate demonstrates sound awareness of health and safety issues.
- The candidate demonstrates sound implementation of risk assessments.
- The candidate demonstrates sound awareness of child protection issues.
- The candidate demonstrates sound awareness of the fitness and health benefits of the activity.
- The overall performance in the officiating is sound and indicative of sound levels of learning and understanding.
- Sound organisational skills in the preparation to officiate activity sessions are demonstrated.

- The candidate demonstrates sound knowledge, understanding and consistent application of the rules, regulations/conventions of the activity.
- There are sound evaluative and reflective skills in relation to sessions officiated.
- The possession of a Governing Body Level Two Officiating qualification (or equivalent) **may** be an indicator of attainment at this standard but the assessment criteria must still be met.

Band 4 (7-12)

- A limited level of basic and advanced officiating skills is demonstrated.
- Some appropriate strategies are successfully used by the candidate demonstrating a limited understanding of the perceptual aspects of officiating.
- The candidate demonstrates limited awareness of health and safety issues.
- The candidate demonstrates limited implementation of risk assessments.
- The candidate demonstrates limited awareness of child protection issues.
- The candidate demonstrates limited awareness of the fitness and health benefits of the activity.
- The overall performance in the officiating is limited and indicative of limited levels of learning and understanding.
- Limited organisational skills in the preparation to officiate activity sessions are demonstrated.
- The candidate demonstrates limited knowledge, understanding and inconsistent application of the rules, regulations/conventions of the activity.
- There are limited evaluative and reflective skills in relation to sessions officiated.
- The possession of a Governing Body Level Two Officiating qualification (or equivalent) **may** be an indicator of attainment at this standard but the assessment criteria must still be met.

Band 5 (0-6)

- A poor level of basic and advanced officiating skills is demonstrated.
- Appropriate strategies are rarely used by the candidate demonstrating a poor understanding of the perceptual aspects of officiating.
- The candidate demonstrates poor awareness of health and safety issues.
- The candidate demonstrates poor implementation of risk assessments.
- The candidate demonstrates poor awareness of child protection issues.

- The candidate demonstrates poor awareness of the fitness and health benefits of the activity.
- The overall performance in the officiating is poor and indicative of limited levels of learning and understanding.
- Poor organisational skills in the preparation to officiate activity sessions are demonstrated.
- The candidate demonstrates little knowledge, understanding and inconsistent application of the rules, regulations/conventions of the activity.
- There are poor evaluative and reflective skills in relation to sessions officiated.

6 Evaluation and Planning for Improvement

Candidates are assessed in their ability to evaluate a performance, create a viable action plan to improve that performance and discuss the opportunities for participation and progression as well as the health and fitness benefits of the activity.

Candidates will observe a live performance by a fellow candidate in one of their own assessed activities and then compare it to the factors that make for an effective and efficient performance. In this they will evaluate:

- the quality of the acquired and developed skills;
- the success of the selection and application of skills, tactics/compositional ideas;
- the fitness and health aspects of the activity observed.

Candidates will give a detailed evaluative oral response using appropriate technical language, in which they discuss:

- the strengths of the performance observed in relation to skills, tactics/compositional ideas and fitness;
- the weaknesses of the performance observed in relation to skills, tactics/compositional ideas and fitness;
- the weaknesses of the performance they would prioritise for improvement;
- an action plan to improve one major weakness of the performance to include detailed coaching points, detailed progressive practices and a timescale;
- opportunities locally and nationally for performers to participate and progress in the activity;
- the health and fitness benefits of the activity observed.

Candidates should observe a fellow candidate's performance in one of their two chosen activities. This performance should be one which is new to them and which they have not seen before. The candidate may, if they wish, make notes as the performance progresses in order to facilitate their response. Pre-prepared notes are not permitted. The candidate should be directed to the performer or aspect of the performance they are to focus on and be reminded of the structure of their response by being given a prompt such as:

'I would like you to observe the performance of..... I would like you to comment on:

- the strengths of the performance observed in relation to skills, tactics/compositional ideas and fitness;
- the weaknesses of the performance observed in relation to skills, tactics/compositional ideas and fitness;
- the weaknesses of the performance you would prioritise for improvement.
- Create a viable action plan to improve *those areas* of performance to include detailed coaching points and detailed progressive practices;
- Describe opportunities locally and nationally for performers to participate and progress in the activity;

- Describe the health and fitness benefits of the activity observed;

If the candidate needs guidance this should be done in the form of prompts which will allow the candidate to express their knowledge, understanding and opinions.

Examples of such prompts are:

- Describe the strengths of the skills applied in the performance you have observed. Describe the strengths of the tactics/strategies applied in the performance you have observed.
- Describe the strengths of the compositional ideas applied in the performance you have observed.
- Describe the strengths of the performer's fitness you have observed.
- Describe the weaknesses of the skills applied in the performance you have observed.
- Describe the weaknesses of the tactics/strategies applied in the performance you have observed.
- Describe the weaknesses of the compositional ideas applied in the performance you have observed.
- Describe the weaknesses of the performer's fitness you have observed.
- Prioritise the weaknesses you have identified.
- Create a viable action plan to improve some of these weaknesses and include detailed coaching points detailed progressive practices and timescale.
- Detail the opportunities locally and nationally for young people to participate in this activity.
- Detail the opportunities locally and nationally for young people to improve in this activity.
- What are the health and fitness benefits of the activity?

Candidates should have a clear structure to their response. This structure should be:

1. Describe the major strengths of the performance in relation to skills, tactics/compositional ideas and fitness.
2. Describe the major weaknesses of the performance in relation to skills, tactics/compositional ideas and fitness.
3. Prioritise the areas of performance which need improvement.
4. Create a viable action plan to improve one major weakness which has; coaching points, progressive practices and a timescale.
5. Describe the opportunities for participation and progression both locally and nationally in the activity.
6. Describe the health and fitness benefits of the activity.

The following assessment criteria are used for the candidate's oral response:

Band 1 (16-20)

The candidate:

- Accurately describes all the major strengths in relation to the skills, tactics/compositional ideas and fitness of the performance observed.
- Accurately describes all the major weaknesses in relation to the skills, tactics/compositional ideas and fitness of the performance observed.
- Accurately prioritises the areas of the performance which need improvement.
- Creates a viable action plan to improve a major weakness which contains all the detailed coaching points, a range of detailed progressive practices together with a timescale.
- Accurately describes fully the range of opportunities both locally and nationally for participation and progression in the activity.
- Accurately describes all the health and fitness benefits of the activity.

Band 2 (11-15)

The candidate:

- Accurately describes most of the major strengths in relation to the skills, tactics/compositional ideas and fitness of the performance observed.
- Accurately describes most of the weaknesses in relation to the skills, tactics/compositional ideas and fitness of the performance observed.
- Prioritises the areas of the performance which need improvement.
- Creates a viable action plan to improve a major weakness which contains detailed coaching points, detailed progressive practices and a timescale.
- Accurately describes most opportunities both locally and nationally for participation and progression in the activity.
- Accurately describes most of the health and fitness benefits of the activity.

Band 3 (6-10)

The candidate with some supplementary prompting:

- Describes some of the major strengths in relation to the skills, tactics/compositional ideas and fitness of the performance observed.
- Describes some of weaknesses in relation to the skills, tactics/compositional ideas and fitness of the performance observed
- Prioritises most of the areas of the performance which need improvement.

- Creates a viable action plan to improve a major weakness which contains some detailed coaching points, some detailed progressive practices and a timescale.
- Describes some of the opportunities both locally and nationally for participation and progression in the activity.
- Describes some of the health and fitness benefits of the activity.

Band 4 (0-5)

The candidate with extensive supplementary prompting:

- Identifies some of the major strengths in relation to the skills, tactics/compositional ideas and fitness of the performance observed.
- Identifies some of weaknesses in relation to the skills, tactics/compositional ideas and fitness of the performance observed.
- Prioritises some of the areas of the performance which need improvement.
- Creates a viable action plan to improve a major weakness which contains few coaching points, few progressive practices and a limited timescale.
- Identifies some of the opportunities both locally and nationally for participation and progression in the activity.
- Identifies some of the health and fitness benefits of the activity.